



making *details* **exceptional**



Writeboards

Slim Board	16	Classic Board	50	Colour Glass Board	76
R · Pet Board	24	Rail Plan	54	Limit Board	80
Classic Magnetic Board	28	Chameleon	60	Ten Limit Board	84
Diptic & Triptic Boards	32	Chameleon Curve	62	Flipcharts	88
Rotating Board	36	Chameleon Wall	64	Screen Board	90
Zenit Board	40	Chameleon Custom	66	Supports	92
Vaiven Board	44	Chameleon Print	68	Accesories	96
Guillotine Board	46	Chameleon Mobile	70		
Basic Board	48	Glass Board	74		

Pinboards

Slim Pinboard	102	Chameleon Geometric Pinboard	124
Bulletin Board	108	Pinboards Showcase	126
R · PET Pinboard	112	Magnetic Showcase	130
Zenit Pinboard	116	Outdoor Showcase	132
Basic Pinboard	120	Outdoor Telescopic Showcase	134
Chameleon Pinboard	122		

Acoustic

PFA Acoustic Panel	140	Ten Limit Acoustic Screen	152	Accessories	167
Screen Acoustic Panel	144	Foam Acoustic	156		
Limit Acoustic Screen	148	R · PET Acoustic	162		

Protect 168

Suspended Screen	172	Glass Screen + Clamps	184	Automatic Gel Dispensers	206
Electric Suspended Screen	174	Ten Limit Acrylic Screen	186	Outdoor Gel Dispensers	210
Acrylic Screen	176	Ten Limit Antibacterial Screen	190	Acces Control	214
Glass Screen	178	Limit Acrylic Screen	194		
Extension Acrylic Screen	180	Limit Antibacterial Screen	198		
Ribbed Acrylic Screen	182	Gel Dispensers	202		

Contract 216

Ten Limit Acrylic Screen	220	Recycling Container / Bin	234	Wall Coat Rack	250
Limit Acrylic Screen	222	Metalic Bin	236	Eco 2 Coat Stand	252
Basic Wastepaper	224	Inox Pedal Bin	238	Eco 4 Coat Stand	256
Self-Extinguising Bin	226	Plastic Pedal Bin	240	Rack Coat Stand	260
Swing Bin	228	Plastic Pedal Container	242	Display Showcase	262
Cubic Bin	230	Outdoor Ashtray	244	Sign System	266
Pedal Bin	232	Coat Stand	248		

Display 272

Snap Frames	276	Grid Panel	286	Next Eco	296
Lecterns Snap Frames	280	Premium Guide Posts	290	Basic Guide Posts	298
Picture Hanging Rail	284	Accessories	294		

Annex 300

Icons guide	301
Colours guide	302

We manufacture accessories for the office, education, home and contract.

Our product collections are created at our facilities in Barcelona after a careful selection process of materials and finishes in which we prioritize sustainability as the main axis in all projects. Achieving aesthetic, functional and sustainable products has been our mission since our inception in 1967. After more than 50 years, and operating in more than 60 countries, we continue to have within our DNA a conviction to create aesthetic, functional and long-lasting products.

Fabricamos accesorios para la oficina, la educación, el hogar y el contract.

Nuestras colecciones de productos se crean en nuestras instalaciones de Barcelona después de un cuidadoso proceso de selección de materiales y acabados, en los que primamos la sostenibilidad como eje principal en todos los proyectos. Conseguir productos estéticos, funcionales y sostenibles es nuestro cometido desde nuestros inicios en 1967. Tras más de 50 años, y operando en más de 60 países, seguimos teniendo en nuestro ADN una convicción de crear productos estéticos, funcionales y longevos.

Nous fabriquons des accessoires pour le bureau, l'éducation, la maison et le contract.

Nos collections de produits sont créées dans nos installations de Barcelone après un processus minutieux de sélection des matériaux et des finitions, dans lequel nous privilégions la durabilité comme axe principal de tous nos projets. La réalisation de produits esthétiques, fonctionnels et durables est notre mission depuis nos débuts en 1967. Après plus de 50 ans, et opérant dans plus de 60 pays, nous avons toujours dans notre ADN la conviction de créer des produits esthétiques, fonctionnels et durables.



We manufacture a wide range of products, responding to our customers demand, and if they require something that we do not have, we design and manufacture it. Aware that customization is part of an intrinsic need, due to the cultural diversity of each company, we adapt our products and can customize them in terms of sizes, finishes, materials and colours.

Standard or specials, we can do it.

Fabricamos una amplia gama de productos, capaces de cubrir el mayor número de necesidades que demanden nuestros clientes, y si requieren algo que no tenemos, lo diseñamos y lo fabricamos. Conscientes de que la personalización forma parte de una necesidad intrínseca, debido a la diversidad cultural de cada compañía, nosotros adaptamos nuestros productos pudiéndolos personalizar en cuanto a medidas, acabados, materiales y colores.

Standard o a medida, podemos hacerlo.





Nous fabriquons une large gamme de produits, capables de couvrir un très grand nombre des demandes de nos clients, si vous avez besoin d'un produit que nous n'avons pas, nous le concevons et le fabriquons pour vous.

Conscients que la personnalisation fait partie d'un besoin intrinsèque, en raison de la diversité culturelle de chaque entreprise, nous adaptons nos produits et pouvons les personnaliser en termes de tailles, de finitions, de matériaux et de couleurs.

Standard ou sur mesure, nous pouvons le faire.



We demonstrate our commitment to reducing our ecological footprint by ensuring the long life of our products. We build a relationship of trust with 0 km suppliers, we practice the circular economy as the foundation of our company, optimising starting with the initial production and design through to installation.

We treat processes, materials, energy use, water and waste management responsibly to reduce negative impacts on the planet. Thinking about a better future for everyone.



Demostramos nuestro compromiso en reducir la huella ecológica asegurando una larga vida útil de nuestros productos. Generamos una relación de confianza con proveedores de km 0, practicamos la economía circular como fundamento base de nuestra empresa, optimizando la producción de nuestras colecciones desde el diseño inicial hasta la instalación en el proyecto.

Tratamos con responsabilidad los procesos, los materiales, el uso de la energía, agua y gestión de residuos para reducir los impactos negativos en el planeta. Pensando en un mejor futuro para todos.

Nous démontrons notre engagement à réduire notre empreinte écologique en assurant une longue durée de vie pour nos produits. Nous générons une relation de confiance avec les fournisseurs de km 0, nous pratiquons l'économie circulaire comme fondement base de notre entreprise, en optimisant la production de nos collections initiale à l'installation dans le projet.

L'optimisation de la production de nos collections, de la conception initiale à l'installation dans le projet.

Nous traitons avec responsabilité les processus, les matériaux, l'utilisation de l'énergie, l'eau et la gestion des déchets afin de réduire les impacts négatifs sur la planète. Pensant en un meilleur avenir pour tous.



And most importantly ... by 2025 more than 50% of the workforce will be millennials ... and it is them that we think of and for whom we create our new products. Aesthetic, fresh and dynamic... but functional and durable. We want to be part of their day to day, meet their demands and help us to improve work environments.

Your happiness is what moves us.

Y lo más importante... en el 2025 más del 50% de la fuerza laboral serán millennials... y es en ellos en quien pensamos y para los que creamos nuestros nuevos productos. Estéticos, frescos y dinámicos... pero funcionales y duraderos. Queremos ser parte de su día a día, cumplir sus exigencias y que nos ayuden a mejorar los entornos de trabajo.

Su felicidad es lo que nos mueve.

Et le plus important... d'ici 2025, plus de 50% des effectifs seront des milléniaux ... et c'est à eux que nous pensons et pour qui nous créons nos nouveaux produits. Esthétiques, frais et dynamiques... mais aussi fonctionnels et durables. Nous voulons faire partie de leur quotidien, répondre à leurs demandes et qu'ils nous aident à améliorer nos environnements de travail.

Votre bonheur c'est ce qui nous motive.

Whiteboards

Slim Board	16
R · Pet Board	24
Classic Magnetic Board	28
Diptic & Triptic Boards	32
Rotating Board	36
Zenit Board	40
Vaiven Board	44
Guillotine Board	46
Basic Board	48
Classic Board	50
Rail Plan	54
Chameleon	60
Chameleon Curve	62
Chameleon Wall	64
Chameleon Custom	66
Chameleon Print	68
Chameleon Mobile	70
Glass Board	74
Colour Glass Board	76
Limit Board	80
Ten Limit Board	84
Flipcharts	88
Screen Board	90
Supports	92
Accesories	96

Writing allows us to understand, process, think, hence in all learning processes, whether at school, university or at work, the blackboard has been, is and will be an indispensable tool. Of course, we leave it up to you the type of drawing board that you like the most or best suits your needs. The act of handwriting stimulates areas of the brain that are also activated when we reflect. Writing by hand is a physical act, as our blackboards are physical, and just as writing says a lot about the character of the person whose writing, blackboards say a lot about the character of their companies.

Escribir nos permite comprender, procesar, pensar, de ahí que en todos los procesos de aprendizaje, ya sea en la escuela, la universidad o en la empresa, la pizarra ha sido, es y será una herramienta indispensable. Eso sí, dejamos a tu elección el tipo de pizarra que más te guste o mejor se adapte a tu espacio. El acto de escribir a mano estimula áreas del cerebro que también se activan cuando reflexionamos. Escribir a mano es un acto físico, como físicas son nuestras pizarras y al igual que la escritura dice mucho del carácter de la persona que escribe, las pizarras dicen mucho del carácter de sus empresas.

L'écriture permet de comprendre, traiter, penser, dans tous les processus d'apprentissage, que ce soit à l'école, à l'université ou en entreprise, le tableau a été, et sera toujours un outil indispensable. Bien entendu, nous vous laissons le choix du type de tableaux que vous aimez le plus ou qui convient le mieux à votre espace. L'acte d'écrire à la main stimule des zones du cerveau qui s'activent lorsque nous réfléchissons. Écrire à la main est un acte physique, aussi physique que sont nos tableaux, et tout comme l'écriture en dit long sur le caractère de la personne qui écrit, les tableaux en disent long sur le caractère de leur entreprise.

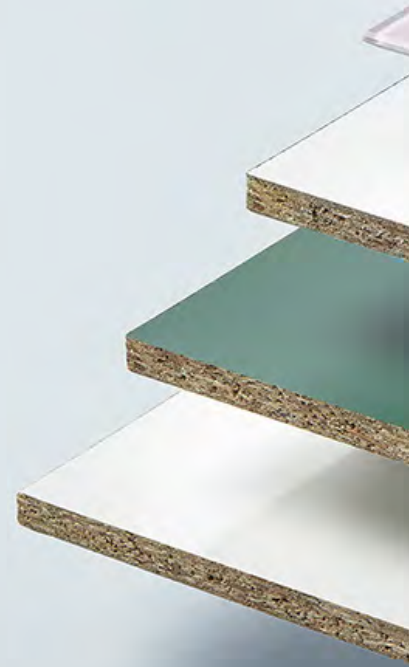



Slim board



White or green drawing board, made from high quality vitrified steel for writing with dry erase markers or chalk. Framed with Slim aluminum profile available in 2 finishes (aluminum and wood), aluminum in matt silver, anthracite and white. Magnetic surface suitable for magnets. Includes 30 cm marker box.

Pizarra mural blanca o verde, fabricada en acero vitrificado de alta calidad para escritura con rotuladores de borrado en seco o tiza. Enmarcada con perfil de aluminio Slim disponible en 2 acabados (aluminio y madera), la de aluminio en plata mate, antracita y blanco. Superficie magnética apta para imanes. Incluye cajetín reposa rotuladores de 30 cm.

Tableau mural blanc ou vert, fabriqué en acier émaillé de haute qualité pour marqueurs effaçables à sec ou craie. Encadré avec un profil en aluminium Slim disponible en 2 finitions (aluminium et bois), aluminium en argent mate, anthracite et blanc. Surface magnétique adaptée aux aimants. Comprend un auget pour marqueurs de 30 cm.

Sizes

FOR WHITEBOARD

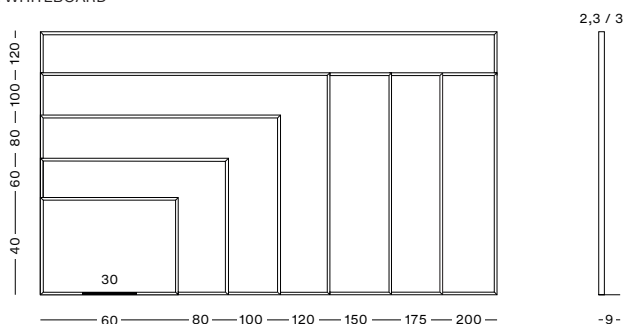

FOR CHALKBOARD

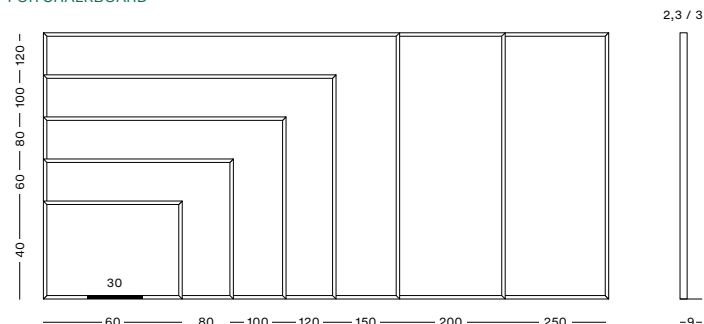

Specs

FOR WHITEBOARD



FOR CHALKBOARD



Slim board

Wood frame

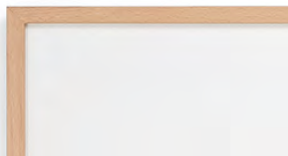

WALL		WHITEBOARD			CHALKBOARD				
	REF	↕ ↔	📏	AV	REF	↕ ↔	📏	AV	↗ ↖
	724/10/WO	40x60 cm 15.7x23.6 in	2,4 Kg 5.2 £			734/10/WO	40x60 cm 15.7x23.6 in	2,4 Kg 5.2 £	
724/1/WO	60x80 cm 23.6x31.5 in	4.8 Kg 10.5 £			734/1/WO	60x80 cm 23.6x31.5 in	4.8 Kg 10.5 £		
724/2/WO	80x100 cm 31.5x39.3 in	8 Kg 17.6 £			734/2/WO	80x100 cm 31.5x39.3 in	8 Kg 17.6 £		
724/3/WO	100x120 cm 39.3x47.2 in	12 Kg 26.4 £			734/3/WO	100x120 cm 39.3x47.2 in	12 Kg 26.4 £		
724/4/WO	100x150 cm 39.3x60 in	15 Kg 33 £			734/4/WO	120x150 cm 47.2x60 in	15 Kg 33 £		
724/5/WO	100x175 cm 39.3x70 in	17.5 Kg 38.5 £			734/5/WO	120x200 cm 47.2x78.7 in	24Kg 52.9 £		
724/6/WO	120x200 cm 47.2x78.7 in	24Kg 52.9 £							

WOOD SUPPORT

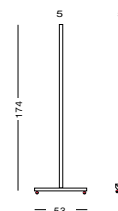

SUPPORT		WHITEBOARD			CHALKBOARD				
	REF	↕ ↔	↕	AV	REF	↕ ↔	↕	AV	↗ ↖
	770/1/WO/1	80x100 cm 31.5x39.3 in	174 cm 68.5 in			770/1/WO/1	80x100 cm 31.5x39.3 in	174 cm 68.5 in	
770/1/WO/2	100x120 cm 39.4x47.2 in				770/1/WO/2	100x120 cm 39.4x47.2 in			📏
770/1/WO/3	100x150 cm 39.4x60 in				770/1/WO/3	120x150 cm 47.2x60 in			7 Kg 15.4 £
770/1/WO/4	100x175 cm 39.4x70 in				770/1/WO/5	120x200 cm 47.2x78.7 in			
770/1/WO/5	120x200 cm 47.2x78.7 in								

*
The reference includes only the supports
La referencia incluye solo los soportes
La référence comprend uniquement les supports

Aluminium frames



WALL WHITEBOARD

						RAIL	T	Y2	AV	
	724/10	724/10/AN	724/10/BL	40x60 cm 15.7x23.6 in	2,4 Kg 5.2 £					2,3 cm 0.9 in
	724/1	724/1/AN	724/1/BL	60x80 cm 23.6x31.5 in	4.8 Kg 10.5 £					
	724/2	724/2/AN	724/2/BL	80x100 cm 31.5x39.3 in	8 Kg 17.6 £	.	.	.		
	724/3	724/3/AN	724/3/BL	100x120 cm 39.3x47.2 in	12 Kg 26.4 £	.	.	.		
	724/4	724/4/AN	724/4/BL	100x150 cm 39.3x60 in	15 Kg 33 £	.	.	.		
	724/5	724/5/AN	724/5/BL	100x175 cm 39.3x70 in	17.5 Kg 38.5 £	.	.	.		
	724/6	724/6/AN	724/6/BL	120x200 cm 47.2x78.7 in	24Kg 52.9 £	.	.	.		

WALL CHALKBOARD

						RAIL	T	Y2	AV	
	734/10	734/10/AN	734/10/BL	40x60 cm 15.7x23.6 in	2,4 Kg 5.2 £					2,3 cm 0.9 in
	734/1	734/1/AN	734/1/BL	60x80 cm 23.6x31.5 in	4.8 Kg 10.5 £					
	734/2	734/2/AN	734/2/BL	80x100 cm 31.5x39.3 in	8 Kg 17.6 £	.	.	.		
	734/3	734/3/AN	734/3/BL	100x120 cm 39.3x47.2 in	12 Kg 26.4 £	.	.	.		
	734/4	734/4/AN	734/4/BL	120x150 cm 47.2x60 in	16 Kg 35 £	.	.	.		
	734/5	734/5/AN	734/5/BL	120x200 cm 47.2x78.7 in	24 Kg 53 £	.	.	.		
	734/6	734/6/AN	734/6/BL	120x250 cm 47.2x98.4 in	27Kg 59.5 £	.	.	.		

MORE DETAILS ABOUT THE SUPPORTS

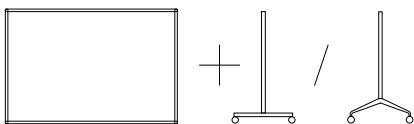

→ VIEW ON PAGE: 92

Slim board

Iron support



SUPPORT

WHITEBOARD

AVAILABLE SIZES

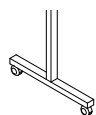

770/1/GR



770/1/AN



770/1/BL



80x100 cm
31.5x39.3 in
100x120 cm
39.3x47.2 in
100x150 cm
39.3x60 in
100x175 cm
39.3x70 in
120x200 cm
47.2x78.7 in



174 cm
68.5 in

7 Kg
15.4 £

53 cm
20.9 in

SUPPORT

CHALKBOARD

AVAILABLE SIZES

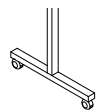

770/1/GR



770/1/AN



770/1/BL



80x100 cm
31.5x39.3 in
100x120 cm
39.3x47.2 in
120x150 cm
47.2x60 in
120x200 cm
47.2x78.7 in



174 cm
68.5 in

7 Kg
15.4 £

53 cm
20.9 in



Aluminium support

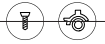
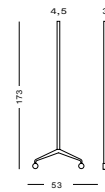

SUPPORT	WHITEBOARD			AVAILABLE SIZES			
	●	●	○	↕ ↔	↕	📦	53 cm 20.9 in
	Y2/80/R	Y2/80/R/AN	Y2/80/R/BL	80x100 cm 31.5x39.3 in	173 cm 68.1 in	5 Kg 11 £	
	Y2/120/R	Y2/120/R/AN	Y2/120/R/BL	100x120 cm 39.3x47.2 in	173 cm 68.1 in	6 Kg 13.2 £	
	Y2/150/R	Y2/150/R/AN	Y2/150/R/BL	100x150 cm 39.3x60 in	173 cm 68.1 in	6,5 Kg 14.3 £	
	Y2/200/R	Y2/200/R/AN	Y2/200/R/BL	120x200 cm 47.2x78.7 in	173 cm 68.1 in	7 Kg 15.4 £	
	Y2/250/R	Y2/250/R/AN	Y2/250/R/BL	120x250 cm 47.2x96.7 in	173 cm 68.1 in	7,5 Kg 16.5 £	

SUPPORT	CHALKBOARD			AVAILABLE SIZES			
	●	●	○	↕ ↔	↕	📦	53 cm 20.9 in
	Y2/80/R	Y2/80/R/AN	Y2/80/R/BL	80x100 cm 31.5x39.3 in	173 cm 68.1 in	5 Kg 11 £	
	Y2/120/R	Y2/120/R/AN	Y2/120/R/BL	100x120 cm 39.3x47.2 in	173 cm 68.1 in	6 Kg 13.2 £	
	Y2/150/R	Y2/150/R/AN	Y2/150/R/BL	120x150 cm 47.2x60 in	173 cm 68.1 in	6,75 Kg 14.8 £	
	Y2/200/R	Y2/200/R/AN	Y2/200/R/BL	120x200 cm 47.2x78.7 in	173 cm 68.1 in	7 Kg 15.4 £	
	Y2/250/R	Y2/250/R/AN	Y2/250/R/BL	120x250 cm 47.2x96.7 in	173 cm 68.1 in	7,5 Kg 16.5 £	



Every year we generate thousands of tons of waste that we are unable to recycle. At Planning Siplamo we do our bit to save the planet, recycling thousands of PET bottles and containers to turn them into a long-life product aimed at training and education. Once again we go ahead by presenting our white boards made with R-pet (recycled Pet) profile and corner pieces.

Generamos cada año miles de toneladas de residuos que somos incapaces de reciclar. Desde Planning Siplamo ponemos nuestro granito de arena para salvar el planeta, reciclando miles de botellas y envases de PET para convertirlos en un producto de larga vida útil y dirigido a la formación y la educación. Una vez más nos adelantamos presentando nuestras pizarras fabricadas con perfil y cantoneras R-pet (Pet reciclado).

Chaque année, nous générons des milliers de tonnes de déchets que nous ne pouvons pas recycler. Chez Planning Siplamo, nous essayons aussi de contribuer à sauver la planète, en recyclant des milliers de bouteilles et contenants en PET pour en faire un produit durable destiné à la formation et à l'éducation. Encore une fois, nous allons de l'avant en présentant nos tableaux fabriqués avec des profilés et des coins R-pet (Pet recyclé).





R · PET Board



Vitrified or laminated steel & slate drawing board, available in white or green, manufactured with profile extrusion and injection of R-PET corner pieces. The PET we use comes from 100% recycled bottles and containers in order to improve the sustainability of the planet by investing in new long-life products for the education and training sector.

Pizarra mural de acero vitrificado o laminado, disponible en blanco o verde, fabricada con extrusión de perfil e inyección de cantoneras de R-PET. El PET que usamos en las pizarras proviene de botellas y envases 100% reciclados con el fin de mejorar la sostenibilidad del planeta invirtiendo en unos nuevos productos de larga vida útil en el sector de la docencia y la formación.

Tableau mural en acier émaillé ou stratifié, disponible en blanc ou vert, fabriqué avec extrusion de profil et injection de pièces d'angle R-PET. Le PET que nous utilisons pour nos tableaux provient de bouteilles et d'emballages 100% recyclés. En investissant dans de nouveaux produits longue durée pour le secteur de l'enseignement et de la formation, nous contribuons à l'amélioration de la durabilité de notre planète.

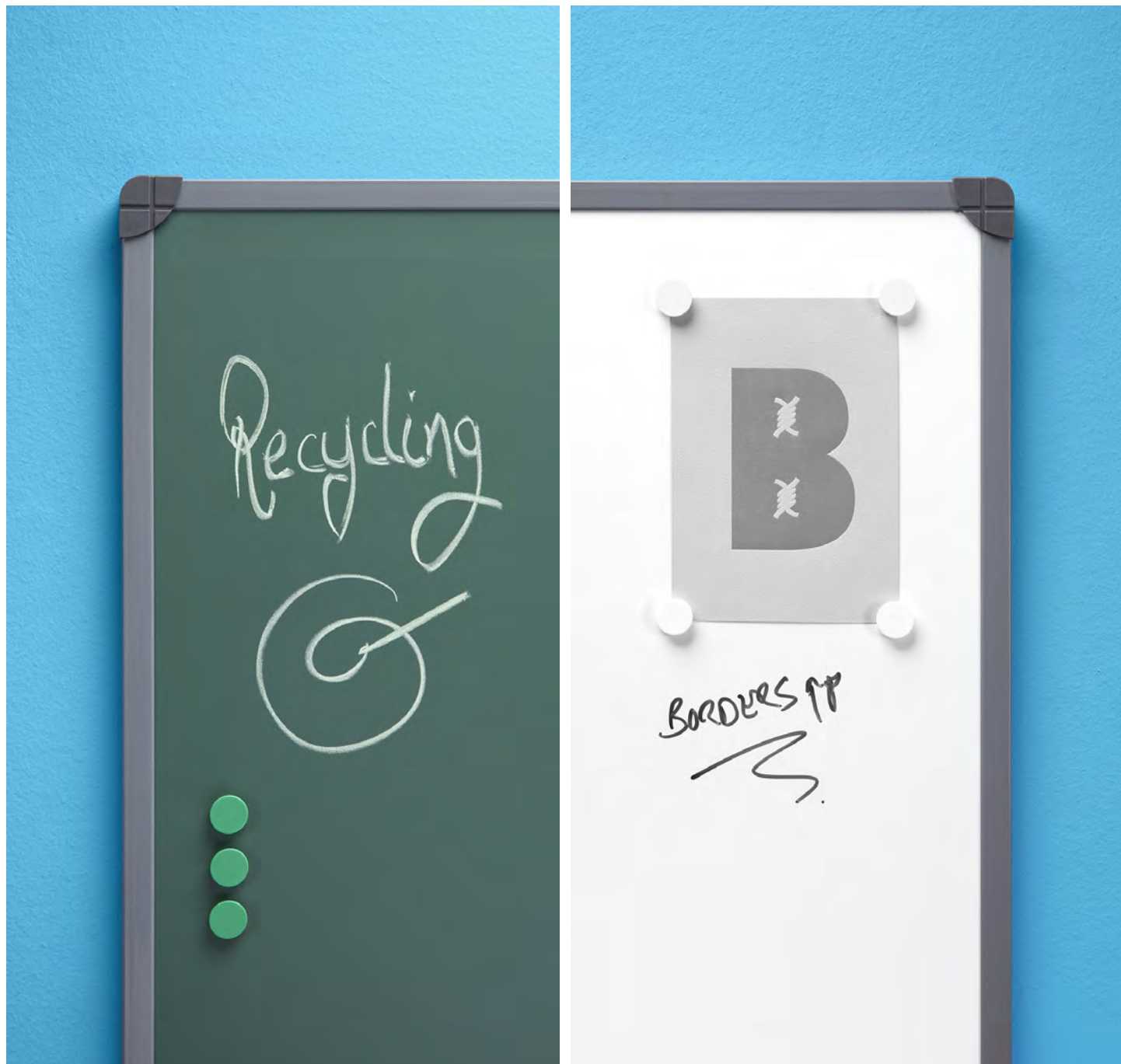

R · PET Board

Sizes

FOR WHITEBOARD

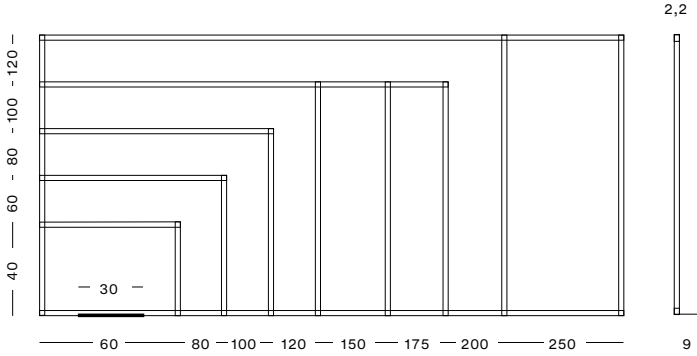

FOR CHALKBOARD

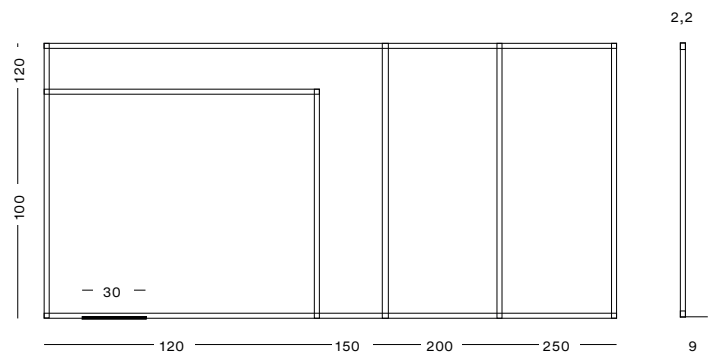

Specs

FOR WHITEBOARD



FOR CHALKBOARD



Recycled frame & corners

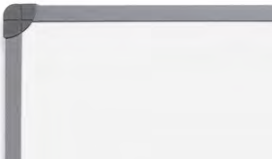

WALL

WHITEBOARD

AV

REF	MATT	↕ ↔	📏
720/10/REC	-	40x60 cm 15.7x23.6 in	2,5 Kg 5.6 £
720/1/REC	-	60x80 cm 23.6x31.4 in	5,1 Kg 11.2 £
720/2/REC	-	80x100 cm 31.4x39.3 in	8,5 Kg 18.7 £
720/3/REC	-	100x120 cm 39.3x47.2 in	12,8 Kg 28.21 £
720/4/REC	720/4/M/REC	100x150 cm 39.3x59.05 in	16 Kg 35.2 £
720/5/REC	-	100x175 cm 39.3x68.8 in	18,6 Kg 41 £
720/6/REC	720/6/M/REC	120x200 cm 47.2x78.7 in	25,6 Kg 56.4 £
720/7/REC	720/7/M/REC	120x250 cm 47.2x98.4 in	32 Kg 70.5 £

CHALKBOARD

AV

↔ ↕





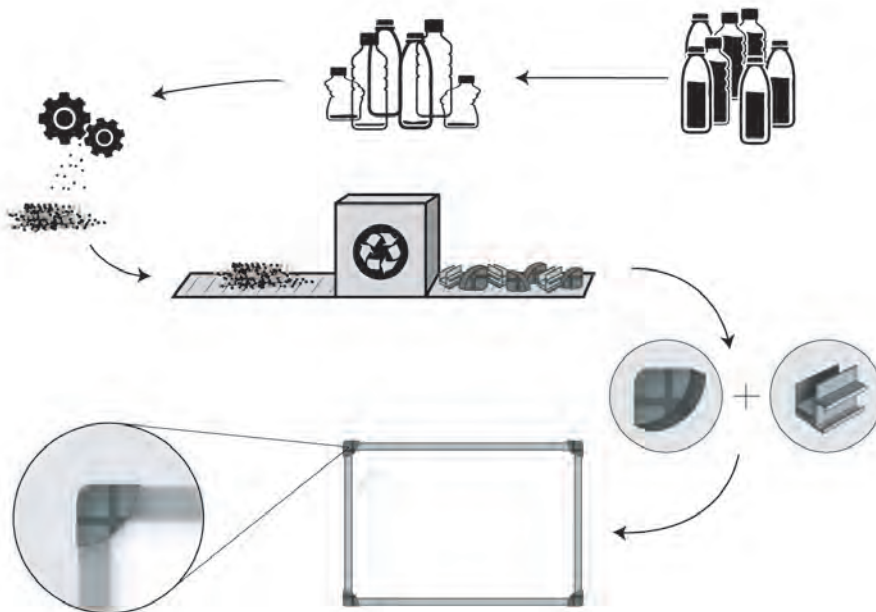

REF	↕ ↔	📏	2,2 cm 0.8 in
730/A1/REC	100x120 cm 39.3x47.2 in	12,8 Kg 28.21 £	
730/A2/REC	120x150 cm 47.2x59.05 in	18 Kg 39.6 £	
730/A3/REC	120x200 cm 47.2x78.7 in	25,6 Kg 56.4 £	
730/A4/REC	120x250 cm 47.2x98.4 in	32 Kg 70.5 £	

Recycled frame & corners



WALL			LM	CHALKBOARD			LM	↔
WHITEBOARD				CHALKBOARD				
REF	↕ ↔	📏		REF	↕ ↔	📏		2,2 cm 0.8 in
725/1/REC	40x60 cm 15.7x23.6 in	2,5 Kg 5.5 £		730/1/REC	100x120 cm 39.3x47.2 in	12 Kg 26.6 £		
725/2/REC	60x80 cm 23.6x31.4 in	4,8 Kg 10.5 £		730/2/REC	120x150 cm 47.2x59.05 in	17 Kg 37.4 £		
725/3/REC	80x120 cm 31.4x47.2 in	9,6 Kg 21.1 £		730/3/REC	120x200 cm 47.2x78.7 in	25,6 Kg 56.4 £		
725/4/REC	100x120 cm 39.3x47.2 in	12 Kg 26.6 £		730/4/REC	120x250 cm 47.2x98.4 in	28 Kg 61.7 £		
725/5/REC	120x150 cm 47.2x59.05 in	15 Kg 37.4 £						
725/6/REC	120x175 cm 47.2x68.8 in	22,5 Kg 49.6 £						
725/7/REC	120x200 cm 47.2x78.7 in	25,6 Kg 56.4 £						
725/8/REC	120x250 cm 47.2x98.4 in	28 Kg 61.7 £						



-  — RPET — 
-  — RPVC — 
-  — WOOD — 

Classic Magnetic Board



White or green drawing board, made from high quality vitrified steel for writing and dry erasing. Framed with Classic aluminum profile and gray plastic corner pieces. Includes 30 cm marker box, and are available in 11 sizes. Magnetic surface available in gloss and matt finish for projection. Ideal drawing board for the education sector reaching 4 meters in one piece.

Pizarra mural blanca o verde, fabricada en acero vitrificado de alta calidad para escritura y borrado en seco. Enmarcada con perfil Classic de aluminio y cantoneras de plástico gris en las esquinas. Incluye cajetín reposa rotuladores de 30 cm. y están disponibles en 11 medidas. Superficie magnética disponible en acabado brillo y mate para proyección. Pizarra ideal para el sector educativo al llegar a 4 metros en una pieza.

Tableau mural blanc ou vert, en acier émaillé de haute qualité pour marqueurs effaçables à sec ou craie. Encadré avec profil en aluminium Classic et des pièces d'angle en plastique gris. Comprend un auget pour marqueurs de 30 cm. 11 dimensions disponibles. Surface magnétique disponible en finition brillante ou mate pour la projection. Tableau idéal pour le secteur de l'éducation, allant jusqu'à 4 mètres d'un seul tenant.

Sizes

FOR WHITEBOARD

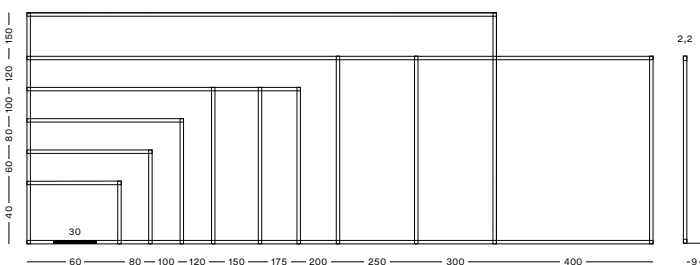

FOR CHALKBOARD

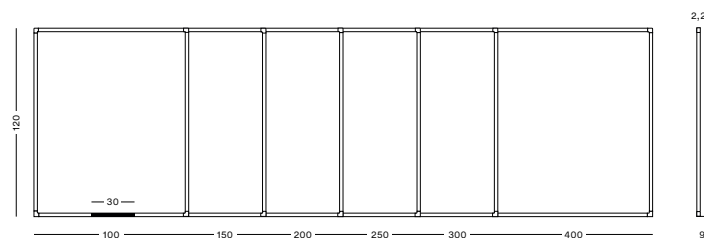

Specs

FOR WHITEBOARD



FOR CHALKBOARD



Classic Magnetic Board

Aluminium frames



WALL							WALL						
WHITEBOARD							CHALKBOARD						
REF	MATT	↕ ↔	⚖	RAIL	T	Y2	REF	↕ ↔	⚖	RAIL	T	Y2	↔ ↵
720/10		40x60 cm 15.7x23.6 in	2,5 Kg 5.6 £				730/A1	120x100 cm 47.2x78.7 in	12,8 Kg 28.21 £	.	.	.	2,2 cm 0.8 in
720/1		60x80 cm 23.6x31.4 in	5,1 Kg 11.2 £				730/A2	120x150 cm 47.2x78.7 in	16 Kg 35.2 £	.	.	.	
720/2		80x100 cm 31.4x39.3 in	8,5 Kg 18.7 £	.	.	.	730/A3	120x200 cm 47.2x78.7 in	25,6 Kg 56.4 £	.	.	.	
720/3		100x120 cm 39.3x47.2 in	12,8 Kg 28.21 £	.	.	.	730/A4	120x250 cm 47.2x98.4 in	32 Kg 70.5 £	.	.	.	
720/4	720/4/M	100x150 cm 39.3x59.05 in	16 Kg 35.2 £	.	.	.	730/A5	120x300 cm 47.2x118.1 in	38,4 Kg 84.6 £	.	.	.	
720/5		100x175 cm 39.3x68.8 in	18,6 Kg 41 £	.	.	.	730/A6	120x400 cm 47.2x157.48 in	51,2 Kg 112.8 £	.	.	.	
720/6	720/6/M	120x200 cm 47.2x78.7 in	25,6 Kg 56.4 £	.	.	.							
720/7	720/7/M	120x250 cm 47.2x98.4 in	32 Kg 70.5 £										
720/8	720/8/M	120x300 cm 47.2x118.1 in	38,4 Kg 84.6 £										
720/9	720/9/M	120x400 cm 47.2x157.48 in	51,2 Kg 112.8 £										
720/15	720/15/M	150x300 cm 59.05x118.1 in	48 Kg 105.8 £										



Grided & Pentagram boards

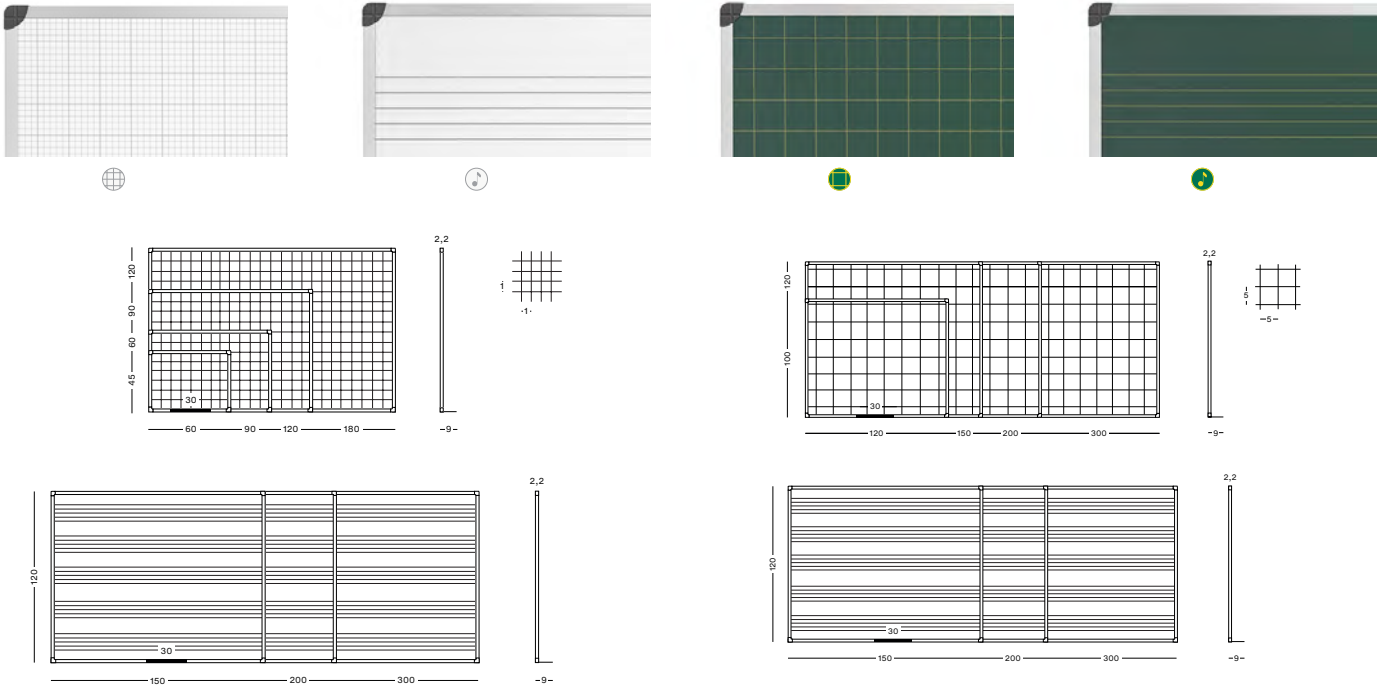

WALL							CHALKBOARD						
WHITEBOARD							CHALKBOARD						
AV							AV						
⊕	↕ ↔	⚖	RAIL	T	Y2		⊕	↕ ↔	⚖	RAIL	T	Y2	2,2 cm 0.8 in
720/C1	45x60 cm 17.7x23.6 in	2,5 Kg 5.6 £					730/A/C1	100x120 cm 39.3x47.2 in	12,8 Kg 28.2 £	▪	▪	▪	
720/C2	60x90 cm 23.6x35.4 in	5,1 Kg 11.2 £	▪				730/A/C2	120x150 cm 47.2x59 in	19,2 Kg 42.3 £	▪	▪	▪	
720/C3	90x120 cm 35.9x47.2 in	8,5 Kg 18.7 £	▪	▪	▪		730/A/C3	120x200 cm 47.2x78.7 in	25,6 Kg 56.4 £		▪	▪	
720/C4	120x180 cm 47.2x71 in	12,8 Kg 28.21 £	▪	▪	▪		730/A/C4	120x300 cm 47.2x118.1 in	38,4 Kg 84.6 £				
⊙	↕ ↔	⚖	RAIL	T	Y2		⊙	↕ ↔	⚖	RAIL	T	Y2	
720/P1	120x150 cm 47.2x59 in	19,2 Kg 42.3 £	▪	▪	▪		730/A/P1	120x150 cm 47.2x59 in	19,2 Kg 42.3 £	▪	▪	▪	
720/P2	120x200 cm 47.2x78.7 in	25,6 Kg 56.4 £		▪	▪		730/A/P2	120x200 cm 47.2x78.7 in	25,6 Kg 56.4 £		▪	▪	
720/P3	120x300 cm 47.2x118.1 in	38,4 Kg 84.6 £					730/A/P3	120x300 cm 47.2x118.1 in	38,4 Kg 84.6 £				

MORE DETAILS ABOUT THE SUPPORTS

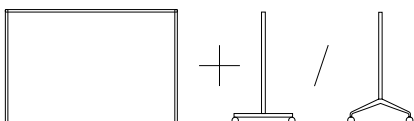

→ VIEW ON PAGE: 92

Diptic & Triptic Boards



White or green Vitrified Steel diptych or triptych drawing board for use with dry erase pens or chalk routers. Framed with a matt silver aluminum profile and rounded gray plastic corners, they include a 30 cm marker box. 3 or 5 writing surfaces depending on the format and are suitable for the use of magnetic material.

Pizarra mural diptica o triptica de acero vitrificado blanca o verde para uso con rotulador de borrado en seco o tiza. Enmarcadas con perfil de aluminio plata mate y cantoneras redondeadas de plástico gris, incluyen cajetín reposa rotuladores de 30 cm. 3 ó 5 superficies de escritura según formato y son aptas para uso de material magnético.

Tableau mural diptyque ou triptyque en acier émaillé blanc ou vert à utiliser avec des marqueurs effaçables à sec ou de la craie. Encadré avec un profil en aluminium argent mate et des coins arrondis en plastique gris, inclus un auget pour marqueurs de 30 cm. 3 ou 5 surfaces d'écriture selon le format. Surface magnétique adaptée aux aimants.



Diptic & Triptic Boards

Diptic Sizes

Aluminium frame

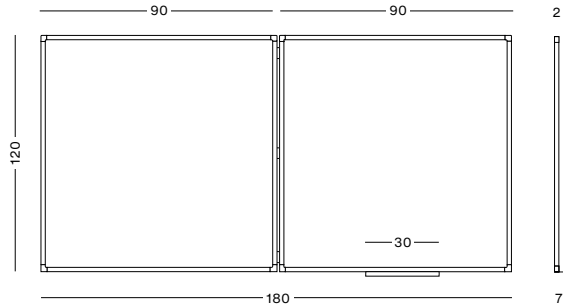

Specs

FOR WHITEBOARD



FOR CHALKBOARD



WALL

WHITEBOARD

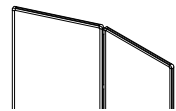

REF	⇕ ⇔ OPEN	⇕ ⇔ CLOSE	👤
720/D1	90x120 cm 35.4x47.2 in	90x60 cm 35.4x23.6 in	16 Kg 35.2 £
720/D2	120x180 cm 47.2x70.8 in	120x90 cm 47.2x35.4 in	24 Kg 52.9 £

CHALKBOARD

→ ←

REF	⇕ ⇔ OPEN	⇕ ⇔ CLOSE	👤	CLOSE / OPEN
730/D1	90x120 cm 35.4x47.2 in	90x60 cm 35.4x23.6 in	16 Kg 35.2 £	4 cm / 2 cm 1.4 in / 0.7 in
730/D2	120x180 cm 47.2x70.8 in	120x90 cm 47.2x35.4 in	24 Kg 52.9 £	



Triptic Sizes

Aluminium frame

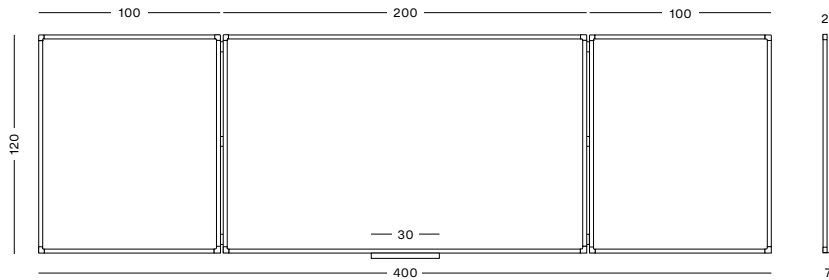

Specs

FOR WHITEBOARD



FOR CHALKBOARD



WALL

WHITEBOARD

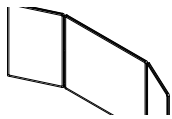

REF	⇕ ⇔ OPEN	⇕ ⇔ CLOSE	👤
720/T1	90x240 cm 35.4x94.4 in	90x120 cm 35.4x47.2 in	32 Kg 70.5 £
720/T2	120x400 cm 47.2x157.4 in	120x200 cm 47.2x78.7 in	51 Kg 112.4 £

CHALKBOARD

→ ←

REF	⇕ ⇔ OPEN	⇕ ⇔ CLOSE	👤	CLOSE / OPEN
730/T1	90x240 cm 35.4x94.4 in	90x120 cm 35.4x47.2 in	32 Kg 70.5 £	4 cm / 2 cm 1.4 in / 0.7 in
730/T2	120x400 cm 47.2x157.4 in	120x200 cm 47.2x78.7 in	51 Kg 112.4 £	



Rotating Board

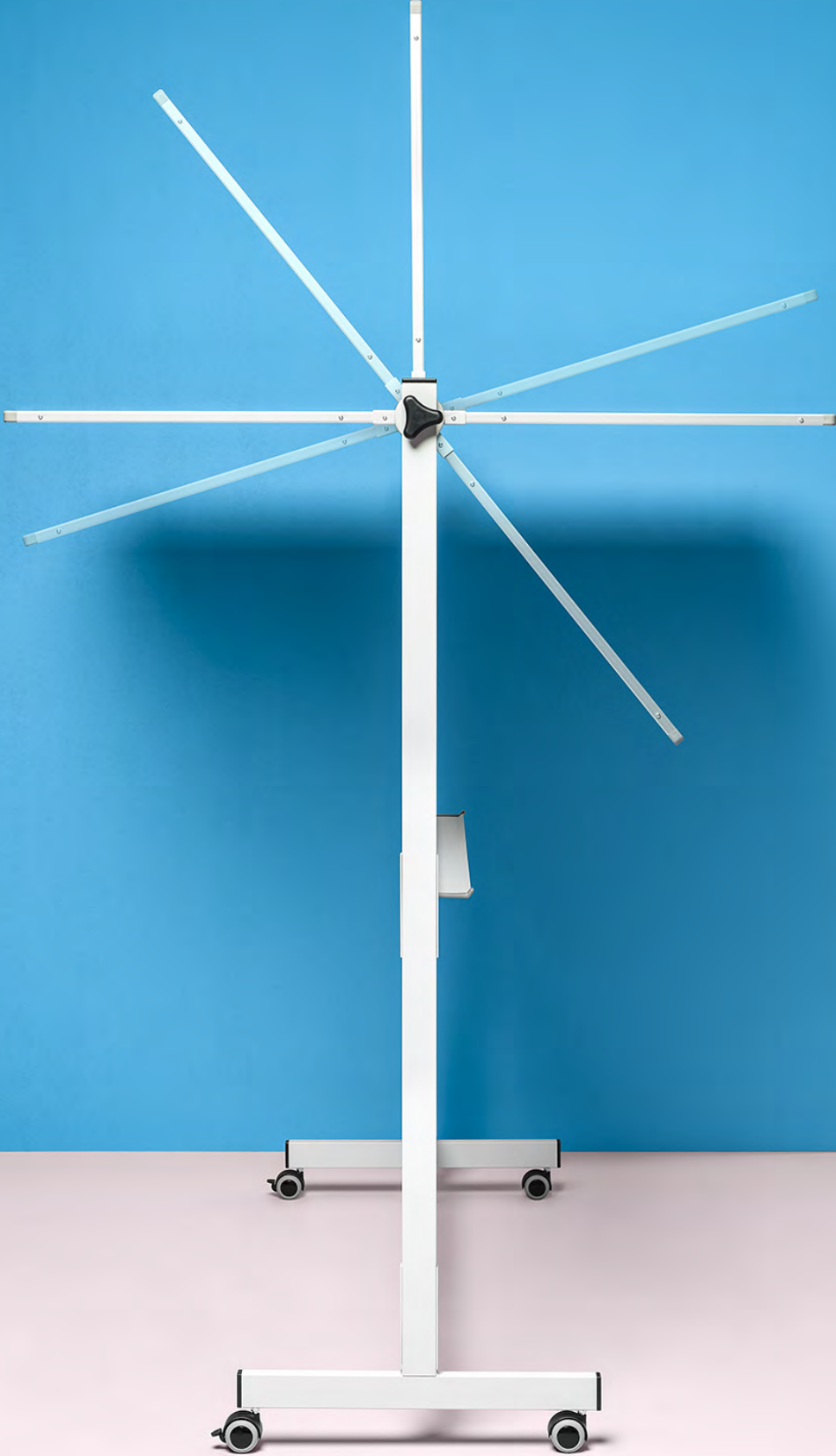

Flip-up double-sided whiteboard made of vitrified or laminated steel, white or green, for use with a dry erase marker or chalk as option. Rotating gray metallic structure provided with 4 castors, 2 with brakes. Framed with a matt silver anodized aluminum profile and rounded gray plastic corner pieces. Includes clamping handle and snap lock.

Pizarra doble cara volteable de acero vitrificado o laminada, blanca o verde para uso con rotulador de borrado en seco o tiza según opción. Estructura metálica gris giratoria provista de 4 ruedas, 2 de ellas con freno. Enmarcada con perfil de aluminio anodizado plata mate y cantoneras redondeadas de plástico gris. Incluye pomo de fijación y bloqueo a presión.

Tableau pivotant double face en acier émaillé ou stratifié, blanc ou vert, à utiliser avec un marqueur effaçable à sec ou une craie selon l'option. Structure métallique grise pivotante dotée de 4 roues dont 2 avec freins. Tableau encadré avec un profil en aluminium anodisé argent mat et des coins arrondis en plastique gris. Comprend une poignée de serrage et un verrou à pression.



Rotating Board

Size

Aluminium frame

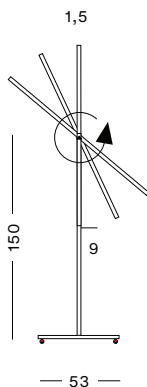
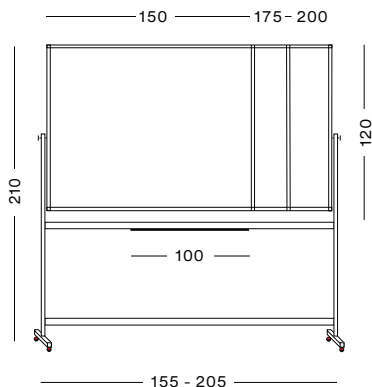

Specs

FOR WHITEBOARD



FOR CHALKBOARD



WHITEBOARD

→ BOARD

→ SUPPORT

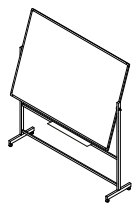

AV	LM	↕ ↔ BOARD	↕	⚖
720/X1	725/X1	120x150 cm 47,2x59,0 in	210 cm 85.6 in	45 Kg 99.2 £
720/X2	725/X2	120x175 cm 47,2x68,8 in	210 cm 85.6 in	53 Kg 116.8 £
720/X3	725/X3	120x200 cm 47,2x78,7 in	210 cm 85.6 in	61 Kg 134.5 £



1,5 cm
0.59 in

53 cm
20.8 in

CHALKBOARD

→ BOARD

→ SUPPORT

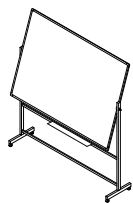

AV	LM	↕ ↔ BOARD	↕	⚖
730/A/X1	730/X1	120x150 cm 47,2x59,0 in	210 cm 85.6 in	45 Kg 99.2 £
730/A/X2	730/X2	120x175 cm 47,2x68,8 in	210 cm 85.6 in	53 Kg 116.8 £
730/A/X3	730/X3	120x200 cm 47,2x78,7 in	210 cm 85.6 in	61 Kg 134.5 £



1,5 cm
0.59 in

53 cm
20.8 in



Zenit Board

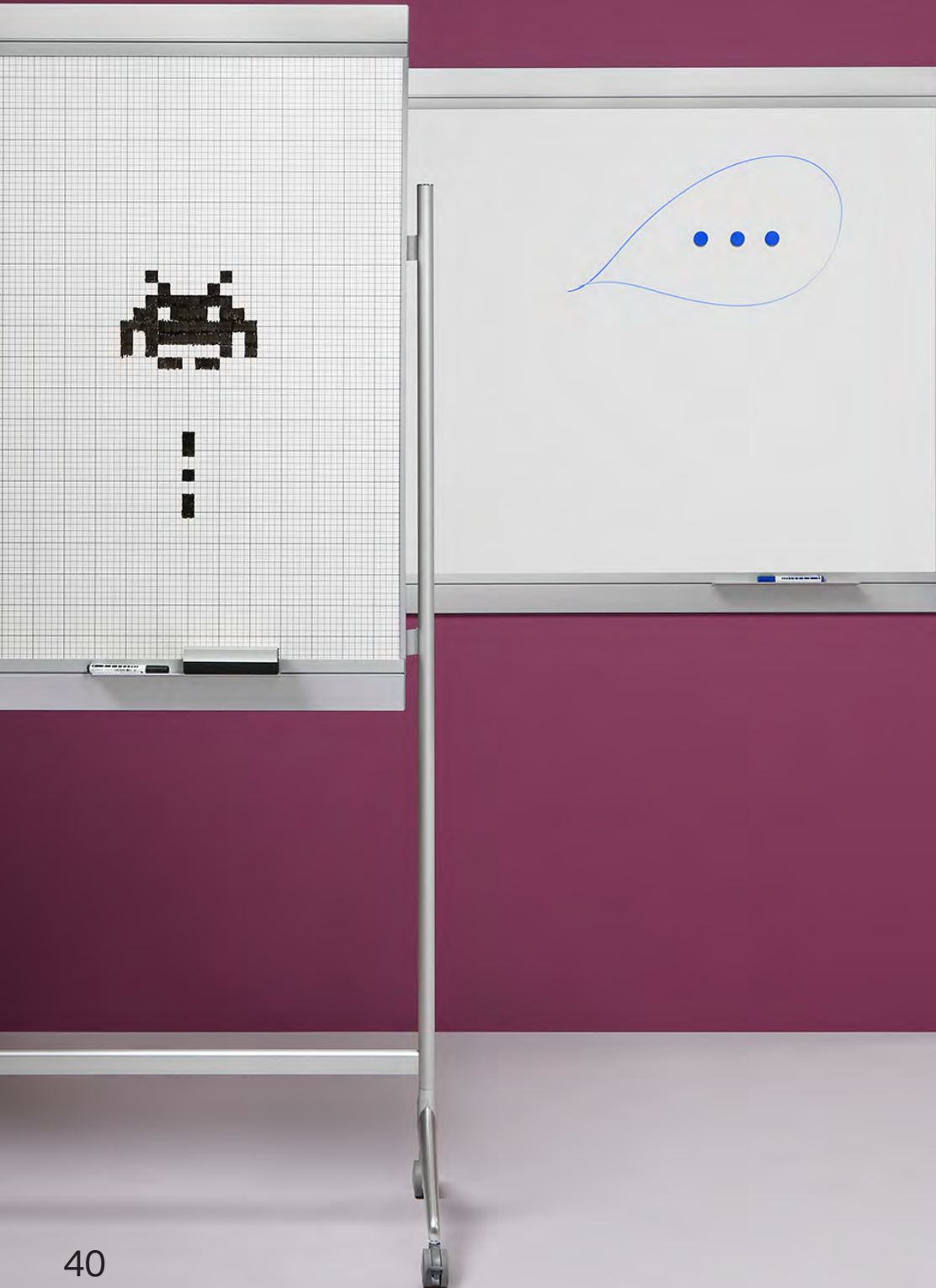

Zenit wall mounted board made of vitrified or laminated steel, white or green for use with a dry erase marker or chalk depending on the option you choose. Aluminum profile with hidden anchors anodized in matt silver colour, includes 30 cm marker holder on box. The magnetic option allows the use of magnets.

Pizarra mural Zenit de acero vitrificado o laminada, blanca o verde para uso con rotulador de borrado en seco o tiza según opción. Perfilería de aluminio con anclajes ocultos anodizada en color plata mate, incluye cajetín reposa rotuladores de 30 cm. La opción magnética permite uso de imanes.

Tableau mural Zenit en acier émaillé ou stratifié, blanc ou vert à utiliser avec un marqueur effaçable à sec ou craie selon la superficie. Profilé en aluminium anodisé couleur argent mat, fixation invisible, comprend un auget porte-marqueur de 30 cm. L'option magnétique permet l'utilisation d'aimants.

Sizes

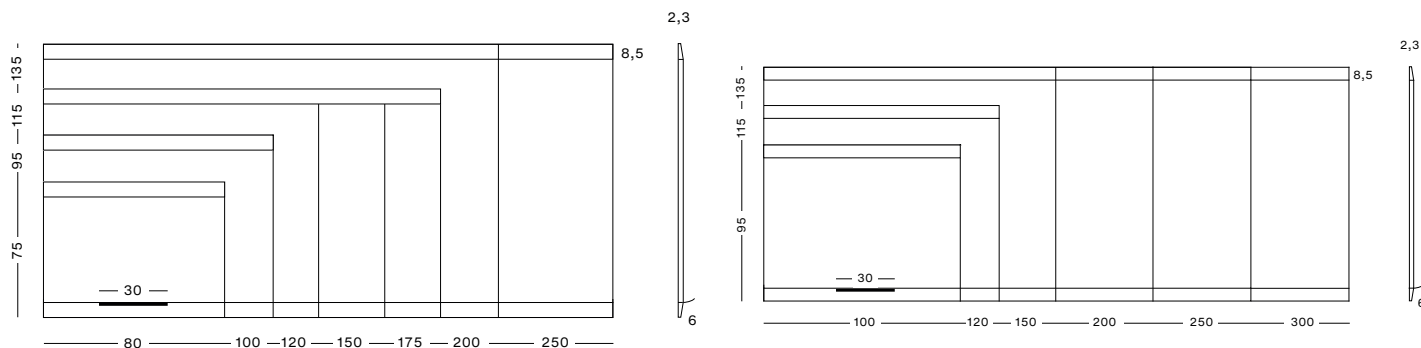

Specs

FOR WHITEBOARD



FOR CHALKBOARD



Zenit Board

Aluminium frames



WALL						WHITEBOARD						CHALKBOARD						→ ←
AV	LM	↕ ↔	⊞	RAIL	Y2	AV	LM	↕ ↔	⊞	RAIL	Y2	2,3 cm						
Z/720/1	Z/725/1	60x80 cm 23.6x31.4 in	6,7 Kg 14.7 in			Z/730/A0	Z/730/0	80x100 cm 31.4x39.3 in	11,5 Kg 25.3 in	•	•	0.9 in						
Z/720/2	Z/725/2	80x100 cm 31.4x39.3 in	11,5 Kg 25.3 in	•	•	Z/730/A1	Z/730/1	100x120 cm 39.3x47.2 in	16 Kg 35.2 in	•	•							
Z/720/3	Z/725/3	100x120 cm 39.3x47.2 in	16 Kg 35.2 in	•	•	Z/730/A2	Z/730/2	120x150 cm 47.2x59.05 in	20 Kg 44.09 in	•	•							
Z/720/4	Z/725/4	100x150 cm 39.3x59.05 in	20 Kg 44.04 in	•	•	Z/730/A3	Z/730/3	120x200 cm 47.2x78.7 in	23 Kg 50.7 in		•							
Z/720/5	Z/725/5	100x175 cm 39.3x68.8 in	23 Kg 50.7 in	•		Z/730/A4	Z/730/4	120x250 cm 47.2x98.4 in	31 Kg 68.3 in									
Z/720/6	Z/725/6	120x200 cm 47.2x78.7 in	31 Kg 68.3 in		•	Z/730/A5	Z/730/5	120x300 cm 47.2x118.11 in	38 Kg 83.7 in									
Z/720/7	Z/725/7	120x250 cm 47.2x98.4 in	38 Kg 83.7 in															

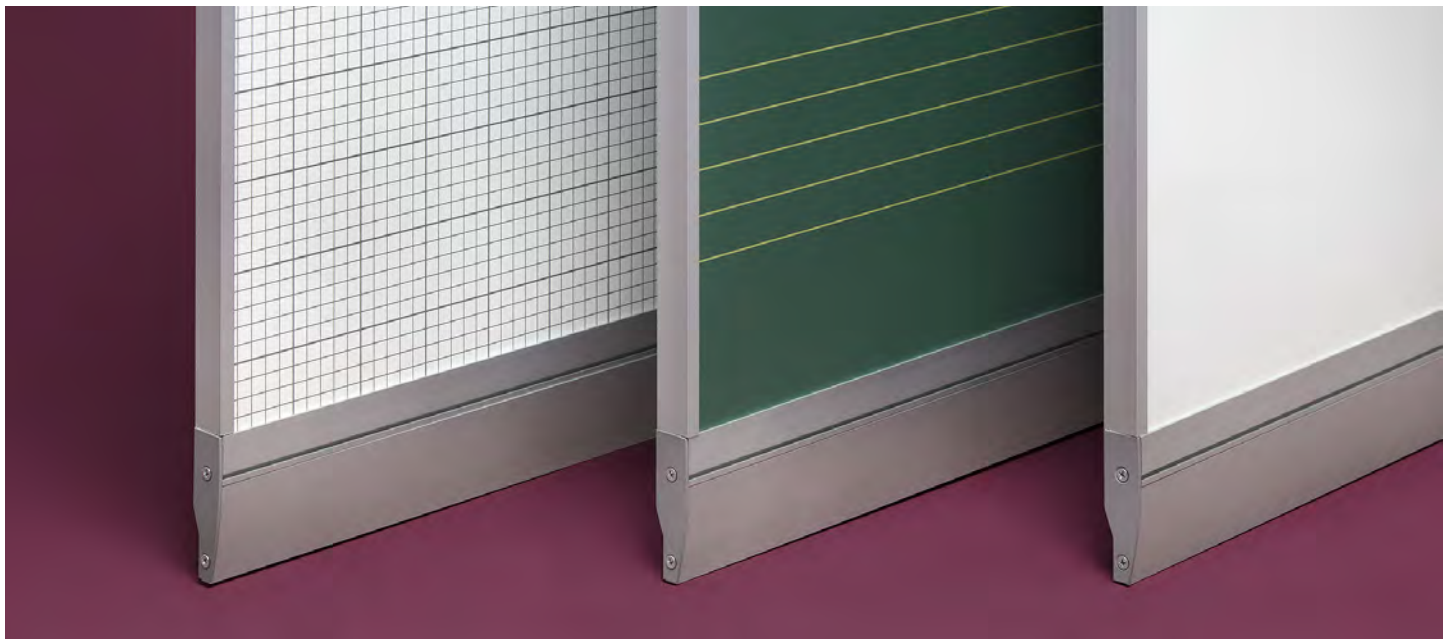

Grided & Pentagram boards

AV

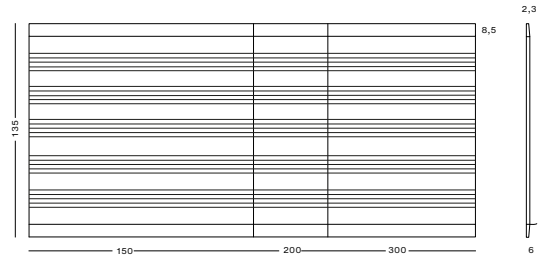
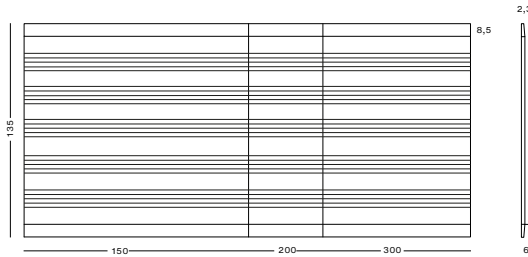
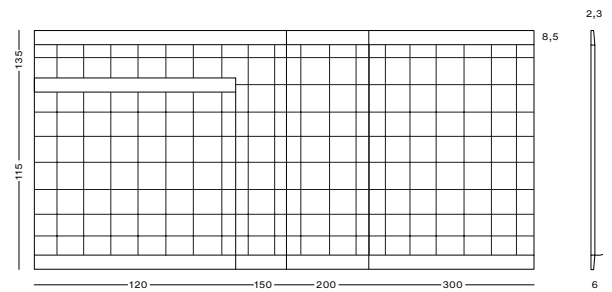
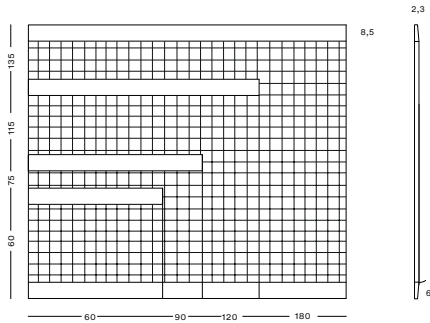

WALL

WHITEBOARD

CHALKBOARD

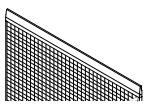

Icon	Model	Dimensions (cm)	Dimensions (in)	Weight (Kg)	Weight (£)	RAIL	Y2
	Z/720/C1	45x60	17.7x23.6	4 Kg	8.8 £		
	Z/720/C2	60x90	23.6x35.4	7,8 Kg	17.1 £		
	Z/720/C3	90x120	35.9x47.2	15,5 Kg	34.1 £		
	Z/720/C4	120x180	47.2x71	31 Kg	68.3 £		

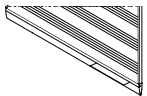

Icon	Model	Dimensions (cm)	Dimensions (in)	Weight (Kg)	Weight (£)	RAIL	Y2
	Z/720/P1	120x150	47.2x59	26 Kg	57.3 £		
	Z/720/P2	120x200	47.2x78.7	35 Kg	77.1 £		
	Z/720/P3	120x300	47.2x118.1	50 Kg	110.2 £		

Icon	Model	Dimensions (cm)	Dimensions (in)	Weight (Kg)	Weight (£)	RAIL	Y2	Thickness
	Z/730/A/C1	100x120	39.3x47.2	17 Kg	37.4 £			2,3 cm 0.9 in
	Z/730/A/C2	120x150	47.2x59	26 Kg	57.3 £			
	Z/730/A/C3	120x200	47.2x78.7	35 Kg	77.1 £			
	Z/730/A/C4	120x300	47.2x118.1	50 Kg	110.2 £			

Icon	Model	Dimensions (cm)	Dimensions (in)	Weight (Kg)	Weight (£)	RAIL	Y2
	Z/730/A/P1	120x150	47.2x59	26 Kg	57.3 £		
	Z/730/A/P2	120x200	47.2x78.7	35 Kg	77.1 £		
	Z/730/A/P3	120x300	47.2x118.1	50 Kg	110.2 £		

MORE DETAILS ABOUT THE SUPPORTS

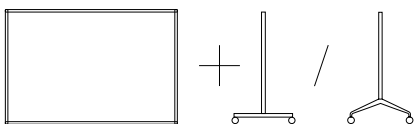

→ VIEW ON PAGE: 92

Vaiven Board



Vaivén blackboard made of white vitrified steel for dry erase markers or green for chalk. Aluminum structure wall or floor mounted. The boards slide easily and are guided in the profiles by nylon bearings. Ideal for schools, universities, amphitheatres, auditoriums... The two blackboards are offset one with the other. When one goes up the other goes down and vice versa.

Pizarra de Vaivén fabricada en acero vitrificado blanca para rotuladores de borrado en seco o verde para tiza. Estructura de aluminio montada sobre suelo y pared. Las pizarras se deslizan con facilidad y van guiadas en los perfiles por rodamientos de nylon. Ideales para colegios, universidades, anfiteatros, auditorios... Las dos pizarras van compensadas la una con la otra. Cuando una sube la otra baja y viceversa.

Tableau Vaivén en acier émaillé blanc pour marqueurs effaçables à sec ou vert pour craie. Structure en aluminium fixée au sol et au mur. Les tableaux coulissent facilement et sont guidés dans les profilés par des roulements en nylon. Idéal pour les écoles, universités, amphithéâtres, auditoriums... Les deux tableaux se compensent l'un avec l'autre. Quand l'un monte, l'autre descend et vice versa.

Sizes

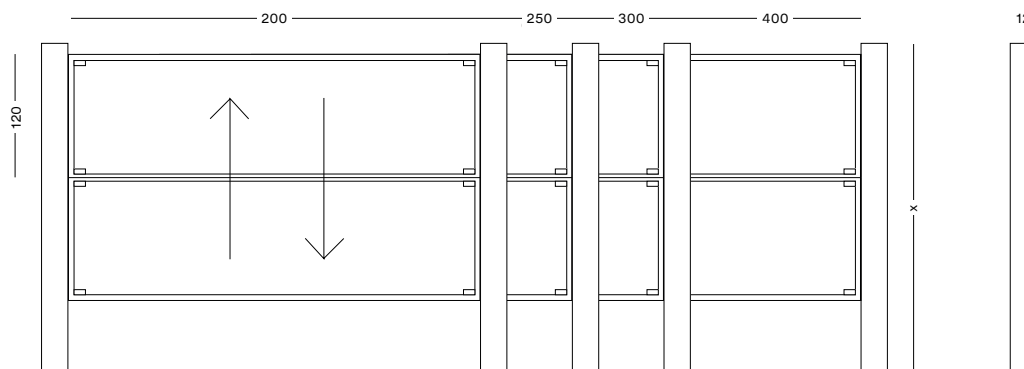

Specs

FOR WHITEBOARD



FOR CHALKBOARD



WALL

WHITEBOARD

CHALKBOARD

↔

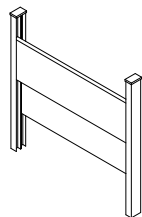

REF	↕ ↔	⚖
720/2/VV1	120x200 cm 47.2x78.7 in	191 Kg 86.6 £
720/2/VV2	120x250 cm 47.2x98.4 in	223 Kg 101.1 £
720/2/VV3	120x300 cm 47.2x118.1 in	256 Kg 116.1 £
720/2/VV4	120x400 cm 47.2x157.48 in	349 Kg 158.3 £

REF	↕ ↔	⚖
730/2/VV1	120x200 cm 47.2x78.7 in	191 Kg 86.6 £
730/2/VV2	120x250 cm 47.2x98.4 in	223 Kg 101.1 £
730/2/VV3	120x300 cm 47.2x118.1 in	256 Kg 116.1 £
730/2/VV4	120x400 cm 47.2x157.48 in	349 Kg 158.3 £

12 cm
4.7 in

Guillotine Board



Guillotine board made of white vitrified steel for dry erase markers or green for chalk. Aluminum structure for wall and or floor mounting. The boards slide easily and are guided within the profiles using nylon bearings. Ideal for schools, universities, amphitheatres, auditoriums ... The two boards are independently compensated. They can be kept one above the other below, or both at the same height.

Pizarra de Guillotina fabricada en acero vitrificado blanca para rotuladores de borrado en seco o verde para tiza. Estructura de aluminio montada sobre suelo y pared. Las pizarras se deslizan con facilidad y van guiadas en los perfiles por rodamientos de nylon. Ideales para colegios, universidades, anfiteatros, auditorios... Las dos pizarras van compensadas de manera independiente. Pueden mantenerse una arriba la otra abajo, o las dos en la misma altura.

Tableau "Guillotine" fabriqué en acier émaillé blanc pour les marqueurs effaçables à sec ou vert pour la craie. Structure en aluminium fixée au sol et au mur. Les tableaux coulissent facilement et sont guidés dans les profilés par des roulements en nylon. Idéal pour les écoles, universités, amphithéâtres, auditoriums ... Les deux tableaux sont indépendants. Ils peuvent être maintenus l'un en haut et l'autre en bas, ou les deux à la même hauteur.

Sizes

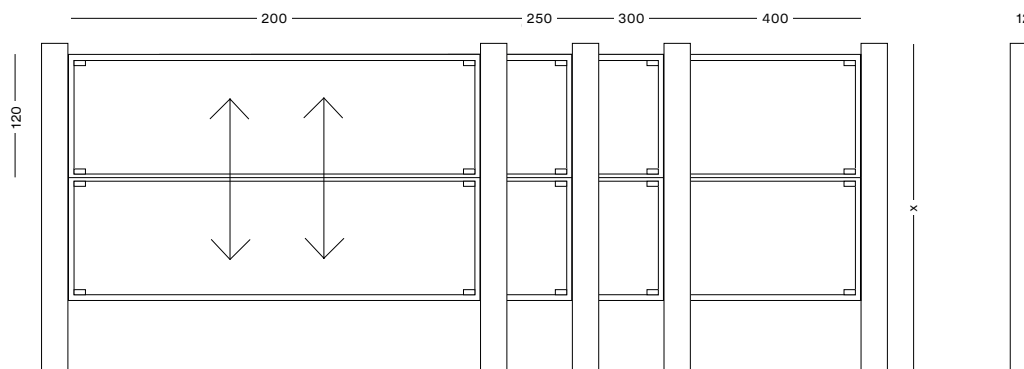

Specs

FOR WHITEBOARD



FOR CHALKBOARD



WALL

WHITEBOARD

CHALKBOARD

↔

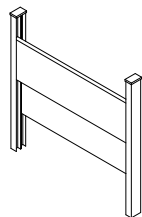

REF	↕ ↔	⚖
720/2/G1	120x200 cm 47.2x78.7 in	210 Kg 462.2 £
720/2/G2	120x250 cm 47.2x98.4 in	226 Kg 498.2 £
720/2/G3	120x300 cm 47.2x118.1 in	236 Kg 520.2 £
720/2/G4	120x400 cm 47.2x157.48 in	255 Kg 562.1 £

REF	↕ ↔	⚖
730/A2/G1	120x200 cm 47.2x78.7 in	210 Kg 462.2 £
730/A2/G2	120x250 cm 47.2x98.4 in	226 Kg 498.2 £
730/A2/G3	120x300 cm 47.2x118.1 in	236 Kg 520.2 £
730/A2/G4	120x400 cm 47.2x157.48 in	255 Kg 562.1 £

12 cm
4.7 in

Basic Board

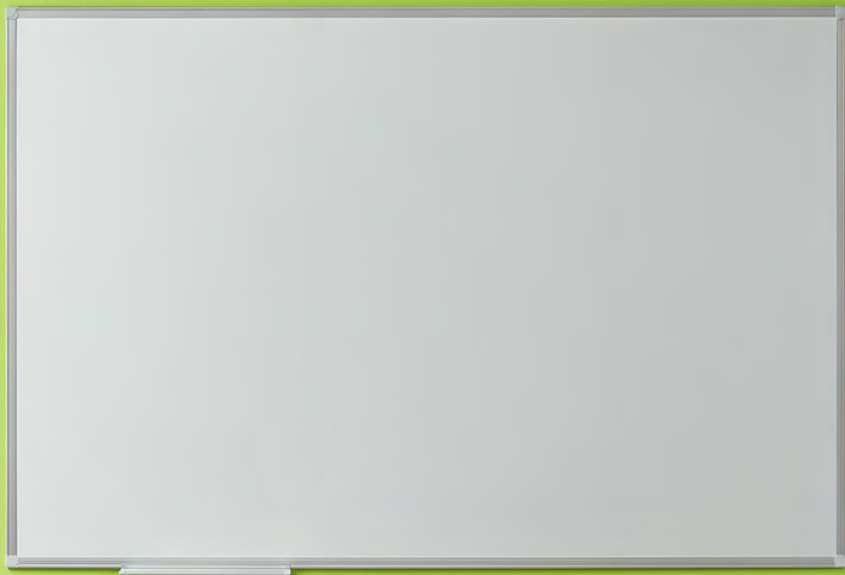

Basic lacquered white board.
Magnetic lacquered surface for writing with dry erase markers.
Framed with matt silver anodized aluminum profile and gray plastic corner pieces. Includes 30 cm marker tray. Allows magnetic material.

Pizarra Basic lacada blanca.
Rotulable en seco. Magnética.
Incluye cajetín reposa rotuladores de 30 cm. Enmarcada con perfil de aluminio anodizado en color plata mate y cantoneras redondeadas de plástico gris.

Tableau blanc laqué Basic.
Surface laquée magnétique pour marqueurs effaçables à sec.
Encadré avec un profil en aluminium anodisé argent mat et des coins en plastique gris. Comprend un auget pour marqueurs de 30 cm. Superficie magnétique.

Sizes

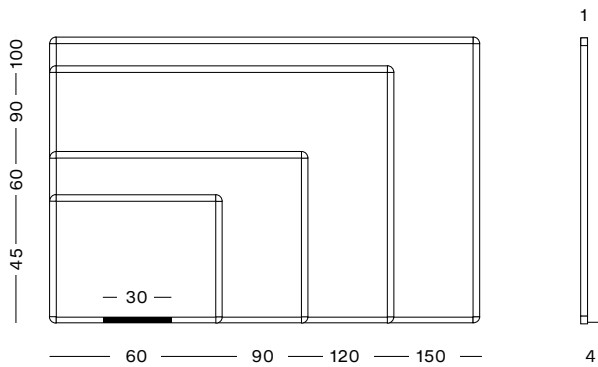

Specs

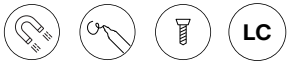

Aluminium frame



WALL	WHITEBOARD		
	REF	↕ ↔	📏 1 cm
	BL/VI/0010	45x60 cm 17.7x23.6 in	2 Kg 4.4 £
	BL/VI/0011	60x90 cm 23.6x35.4 in	4 Kg 8.82 £
	BL/VI/0012	90x120 cm 35.4x47.2 in	8 Kg 17.64 £
	BL/VI/0013	100x150 cm 39.3x59 in	11 Kg 24.25 £



Classic Board

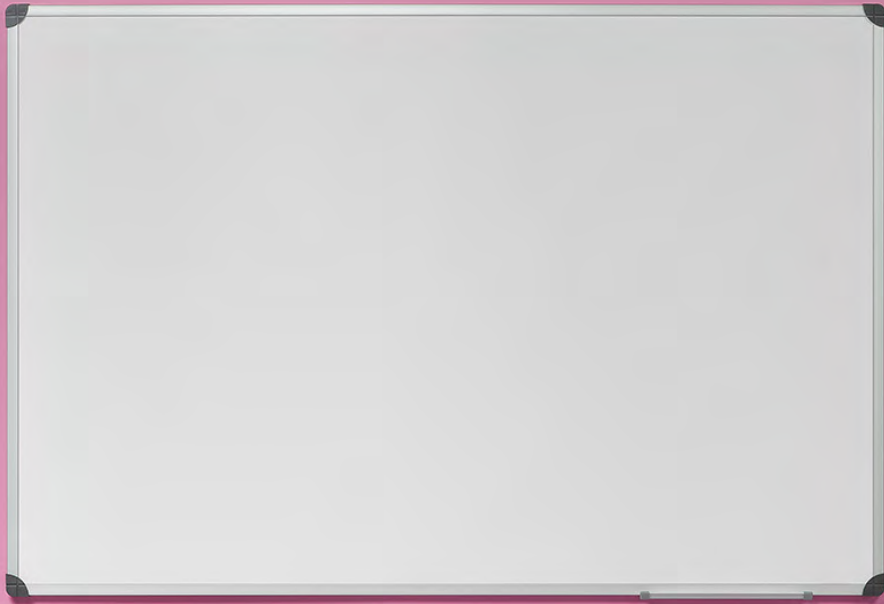

White or green wall board, made using high quality laminate for writing with dry erase markers or chalk. Framed with Classic aluminum profile and gray plastic corner pieces. Includes 30 cm marker box. and they are available in multiple sizes. The larger sizes made in 2 sections.

Pizarra mural blanca o verde, fabricada en laminado de alta calidad para escritura con rotuladores de borrado en seco o tiza. Enmarcada con perfil de aluminio Classic y cantoneras de plástico gris en las esquinas. Incluye cajetín reposa rotuladores de 30 cm. y están disponibles en múltiples medidas. Las más grandes están fabricadas en 2 piezas.

Tableau mural blanc ou vert, fabriqué en stratifié de haute qualité pour marqueurs effaçables à sec ou craie. Encadré avec profil en aluminium classique et des pièces d'angle en plastique gris. Comprend un auget pour marqueurs de 30 cm. Disponible en plusieurs dimensions. Les plus grands sont fabriqués en 2 pièces.



Classic Board

Sizes

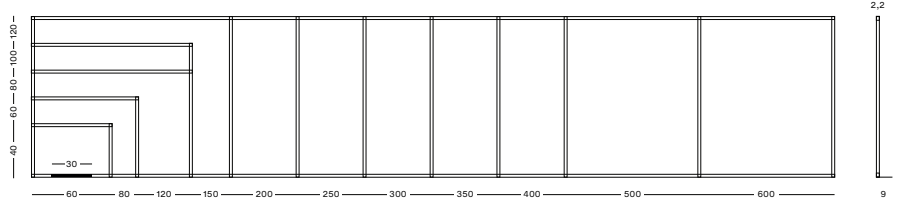
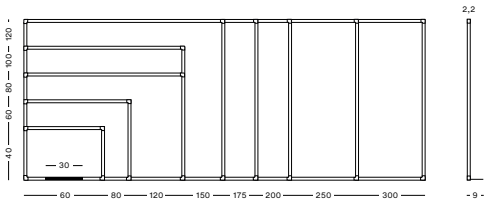

Specs

FOR WHITEBOARD

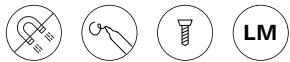

FOR CHALKBOARD

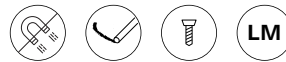

Aluminium frames



WALL						WHITEBOARD	CHALKBOARD						→ ←
LM	↕ ↔	⚖️	RAIL	T	Y2		LM	↕ ↔	⚖️	RAIL	T	Y2	2,2 cm 0.8 in
725/1	40x60 cm 15.74x23.6 in	2,5 Kg 5.5 £					730/11	40x60 cm 15.7x23.6 in	2,5 Kg 5.5 £				
725/2	60x80 cm 23.6x31.4 in	4,8 Kg 10.5 £					730/12	60x80 cm 23.6x31.4 in	4,8 Kg 10.5 £				
725/3	80x120 cm 31.4x47.2 in	9,6 Kg 21.1 £	•	•	•		730/1	80x120 cm 31.4x47.2 in	9,6 Kg 21.1 £	•	•	•	
725/4	100x120 cm 39.3x47.2 in	12 Kg 26.4 £	•	•	•		730/2	100x120 cm 39.3x47.2 in	12 Kg 26.4 £	•	•	•	
725/5	120x150 cm 47.2x59.0 in	17 Kg 37.4 £	•	•	•		730/3	120x150 cm 47.2x59.05 in	17 Kg 37.4 £	•	•	•	
725/6	120x175 cm 47.2x68.8 in	22,5 Kg 49.6 £	•	•	•		730/4	120x200 cm 47.2x78.7 in	25,6 Kg 56.4 £		•	•	
725/7	120x200 cm 47.2x78.7 in	25,6 Kg 56.4 £		•	•		730/5	120x250 cm 47.2x98.4 in	28 Kg 61.7 £				
725/8	120x250 cm 47.2x98.4 in	28 Kg 61.7 £					730/6	120x300 cm 47.2x118.1 in	32 Kg 70.5 £				
725/9	120x300 cm 47.2x118.1 in	32 Kg 70.5 £					730/7*	120x350 cm 47.2x137.7 in	40 Kg 88.1 £				
							730/8*	120x400 cm 47.2x157.48 in	48 Kg 105.8 £				
							730/9*	120x500 cm 47.2x196.8 in	60 Kg 132.2 £				
							730/10*	120x600 cm 47.2x236.2 in	62 Kg 136.6 £				

* Made from 2 pieces - Fabricado en 2 piezas - Fabriqué en 2 pièces

AVAILABLE IN PINBOARD FINISH



→ VIEW ON PAGE: 111

MORE DETAILS ABOUT THE SUPPORTS

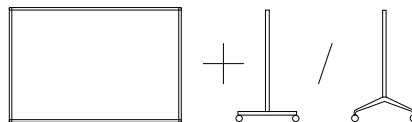

→ VIEW ON PAGE: 92

Rail Plan



Rail Plan is a white lacquered aluminum profile, fixed to the wall, which allows blackboards and boards to be hung on its two rails, allowing easy movement longitudinally to achieve a multipurpose space for presentations and meetings in board rooms, classrooms or the office. It also incorporates a lower rail to hold posters or plans without damaging them.

Rail Plan es un perfil de aluminio lacado blanco, fijado a la pared, el cual permite colgar en sus dos carriles pizarras y tableros, pudiendo desplazarlos longitudinalmente para conseguir un espacio polivalente en las presentaciones y reuniones en una sala, aula u oficina. Además incorpora un carril inferior para sujetar pósters o planos sin dañarlos.

Rail Plan est un profilé en aluminium laqué blanc fixé au mur, qui permet d'accrocher des tableaux blancs et des tableaux d'affichage sur ses deux rails, et de pouvoir les déplacer longitudinalement pour réaliser un espace polyvalent pour des présentations et des réunions dans une salle, une classe ou un bureau. Il intègre également un rail inférieur pour accrocher des affiches ou des plans sans les endommager.



Rail Plan

Sizes

Specs

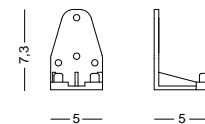
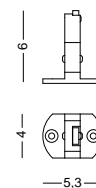
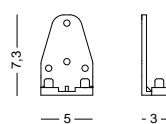
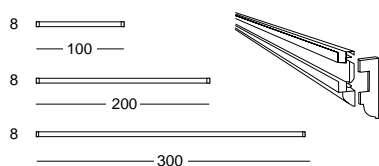
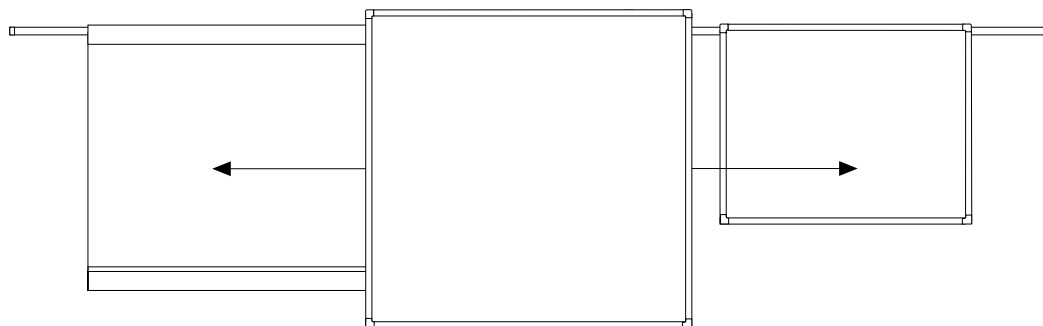

WALL

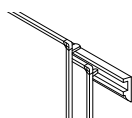

REF	↕ ↔	📏
RP/000	- x8 cm - x3 in	1 Kg 2.2 £
RP/100	8x100 cm 2x39.4 in	1 Kg 2.2 £
RP/200	8x200 cm 3x78.7 in	2 Kg 4.4 £
RP/300	8x300 cm 3x118 in	3 Kg 6.6 £

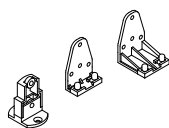

REF	↕ ↔	📐
RP/30	2,5x5 cm 1x2 in	
RP/L	5x8 cm 2x3 in	90°

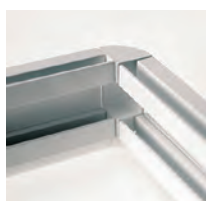

Compatible boards

FOR WHITEBOARD

FOR CHALKBOARD

FOR PINBOARD

FOR PINBOARD COLOR

Slim Board [→ VIEW ON PAGE: 16](#) Slim Pinboard [→ VIEW ON PAGE: 102](#)

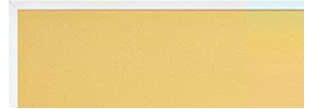
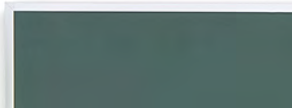

Classic Magnetic Board [→ VIEW ON PAGE: 28](#) Classic Pinboard [→ VIEW ON PAGE: 108](#)

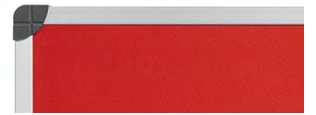
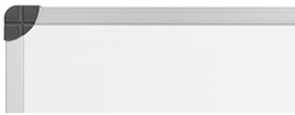

R·Pet Board [→ VIEW ON PAGE: 24](#) R·PET Pinboard [→ VIEW ON PAGE: 112](#)

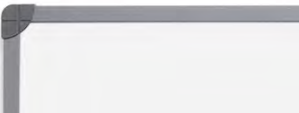

Zenit Board [→ VIEW ON PAGE: 40](#) Zenit Pinboard [→ VIEW ON PAGE: 116](#)



It is possible to write without limit thanks to the range of chameleon drawing boards. Since ideas don't run out, your board shouldn't either ... that's why we present this endless range of drawing boards. If it fits on the wall ... we will make it for you ... and to complement it, the pinboard range allows you to alternate board and board to cover all the needs your space requires. You just have to take action.

Es posible escribir sin límite gracias a la gama de pizarras chameleon. Ya que las ideas no se agotan, tu pizarra tampoco debe terminar... es por eso que presentamos la gama de pizarra sin fin. Si te cabe en la pared... nosotros te la fabricamos... y para complementar, la gama pinboard permite alternar pizarra y tablero para cubrir todas las necesidades que tu espacio necesite. Sólo tienes que tomar medidas.

Il est possible d'écrire sans limite grâce à la gamme de tableau Chameleon. Puisque les idées ne s'épuisent pas, votre tableau ne devrait pas s'arrêter non plus ... c'est pourquoi nous présentons cette gamme de tableau sans fin. S'il s'adapte à votre mur ... nous le fabriquerons pour vous ... et pour le compléter, la gamme de tableaux d'affichage pinboard vous permet d'alterner tableau et panneau d'affichage pour couvrir tous les besoins dont votre espace a besoin. Il vous suffit simplement de prendre les mesures.

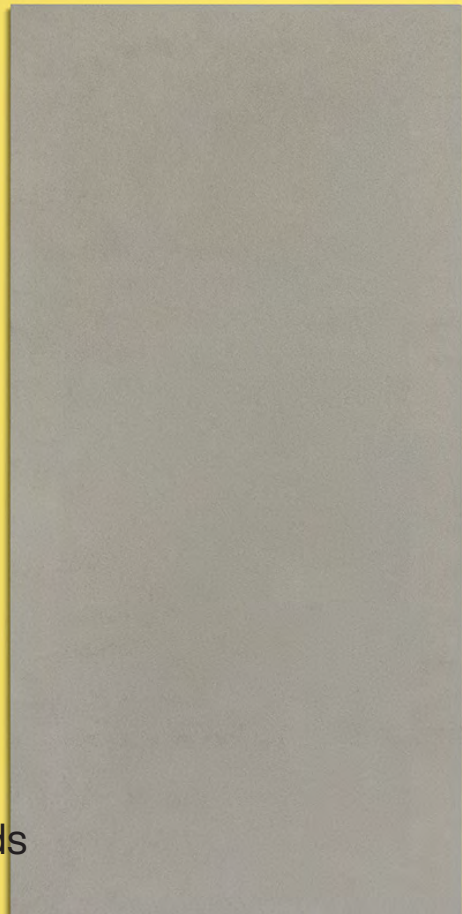
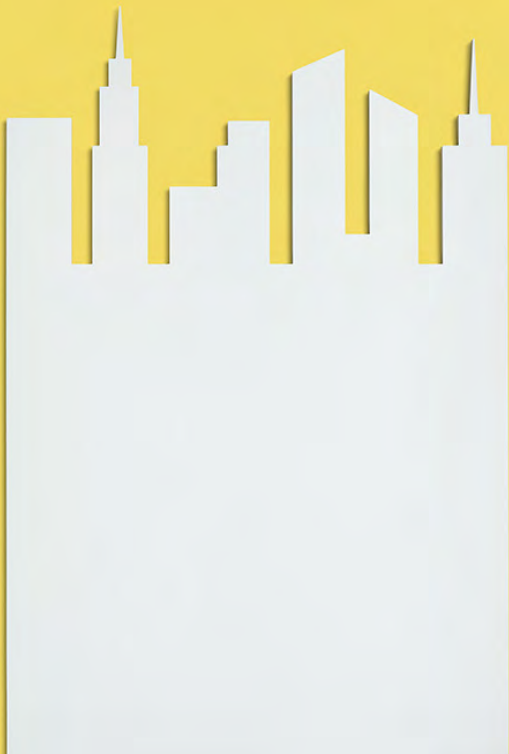
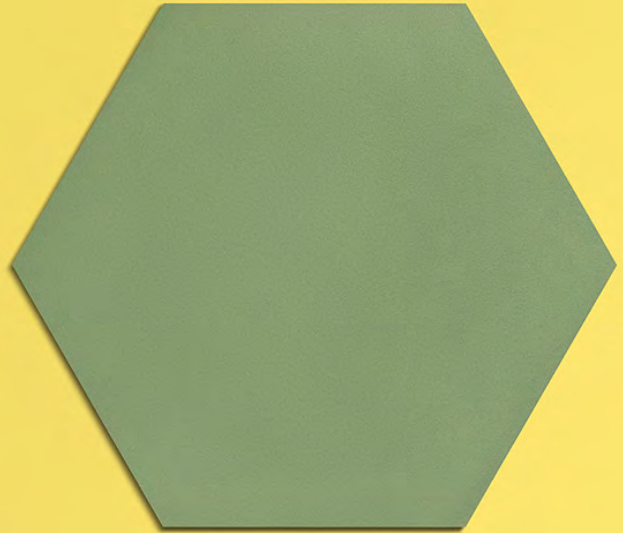
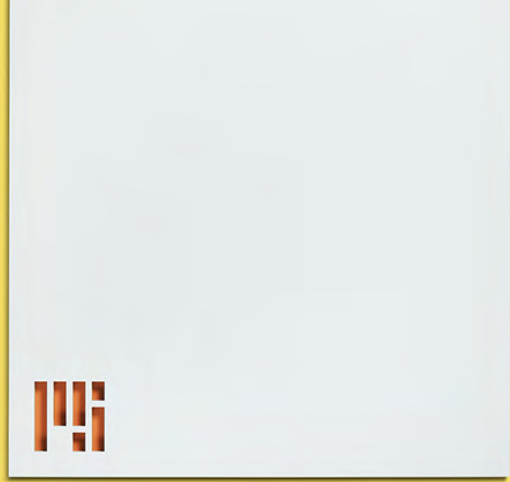
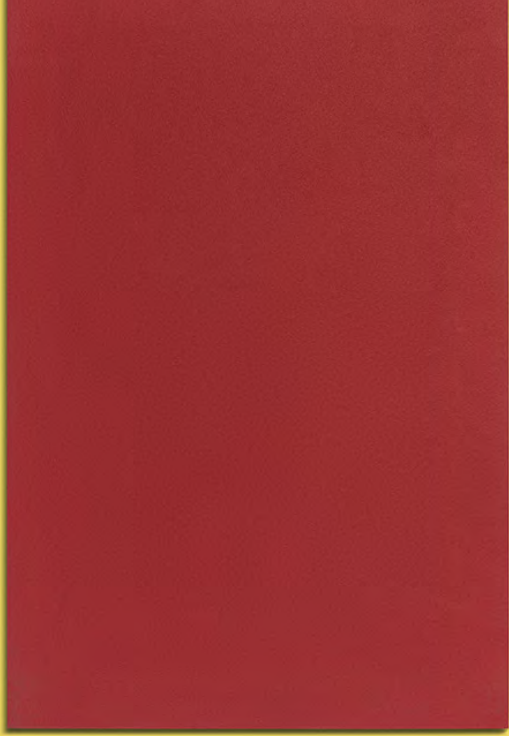

Chameleon Sharp

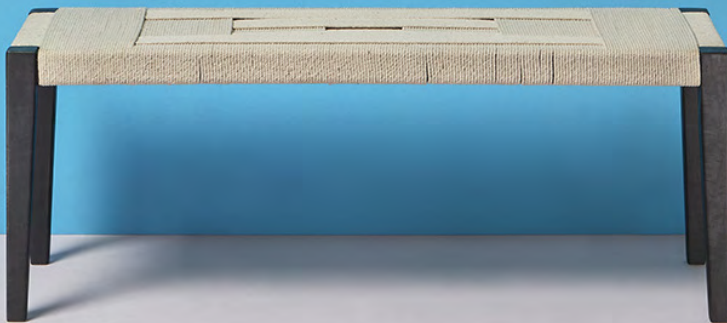
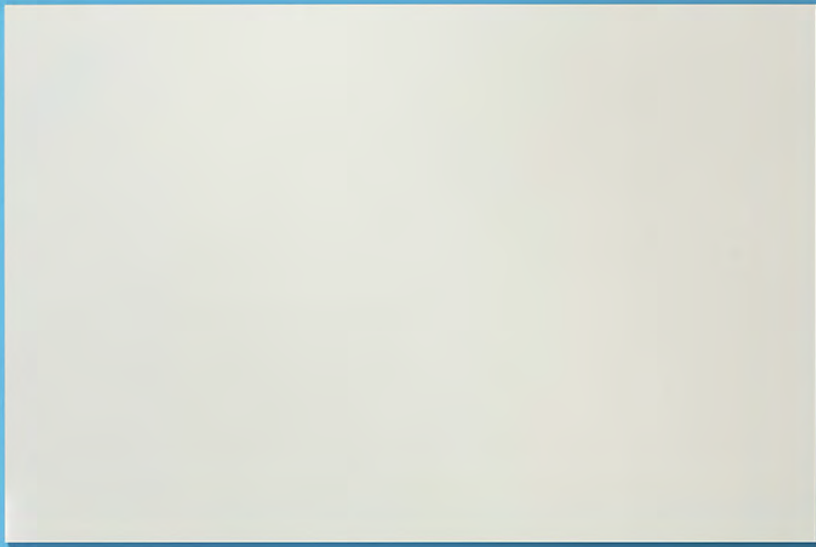

White vitrified steel slate board with 10 mm 90° corners width without frame for writing with dry erase markers. Manufactured by water jet cutting and water-repellent wood that give their white or black lacquered edges a perfect finish. Magnetic surface with lifetime warranty, scratch resistant. Available in gloss and matt finish for projection.

Pizarra de acero vitrificado blanca con esquina de 90° de 10 mm. de grosor sin marco para escritura con rotuladores de borrado en seco. Fabricadas mediante corte de chorro de agua y madera hidrófuga que hace que sus bordes lacados en blanco o negro queden con un acabado perfecto. Superficie magnética con garantía de por vida, resistente a rayaduras. Disponible en acabado brillo y mate para proyección.

Tableau en acier émaillé blanc de 10 mm d'épaisseur et angle à 90°, sans cadre pour marqueurs effaçables à sec. Fabriqué en bois hydrofuge et découpé au jet d'eau ce qui lui confère des bords laqués blancs ou noirs d'une finition parfaite. Surface magnétique garantie à vie, résistante aux rayures. Disponible en finition brillante et mate pour la projection.

Sizes

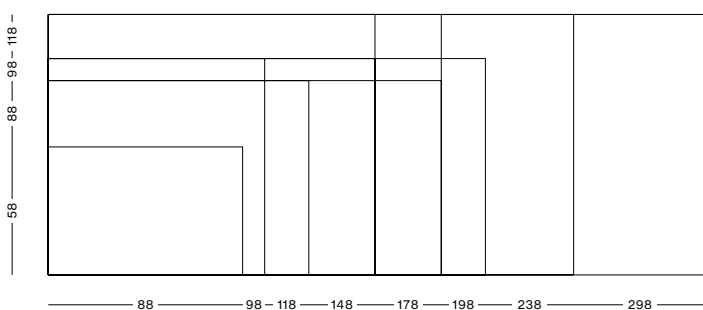

Specs



No frame

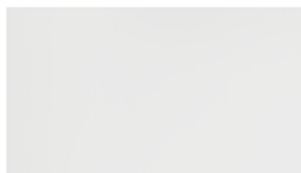

WALL WHITEBOARD ↔ ↵

AV	MATT	↕ ↔	📏	1 cm
7201/10		58x88 cm 22.8x34.6 in	7,66 Kg 16.8 £	0.4 in
7201/1		88x118 cm 34.6x46.4 in	15,58 Kg 34.3 £	
7201/2		88x178 cm 34.6x70 in	23,5 Kg 51.8 £	
7201/3		98x98 cm 38.6x38.6 in	15,41 Kg 33.9 £	
7201/4		98x148 cm 38.6x58.3 in	21,76 Kg 47.9 £	
7201/5		98x198 cm 38.6x80 in	29,11 Kg 64.1 £	
7201/6	7201/6/M	118x148 cm 46.4x58.3 in	26,2 Kg 57.7 £	
7201/7	7201/7/M	118x178 cm 46.4x70 in	31,51 Kg 69.4 £	
7201/8	7201/8/M	118x238 cm 46.4x93.7 in	42,13 Kg 92.8 £	
7201/9	7201/9/M	118x298 cm 46.4x117.3 in	52,75 Kg 116.2 £	

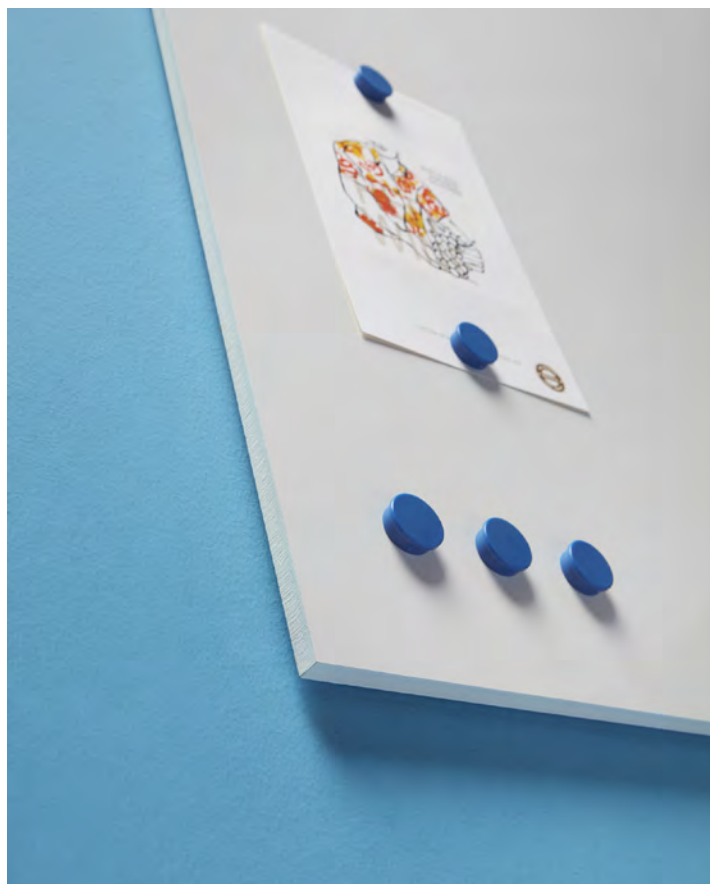

Chameleon Curve

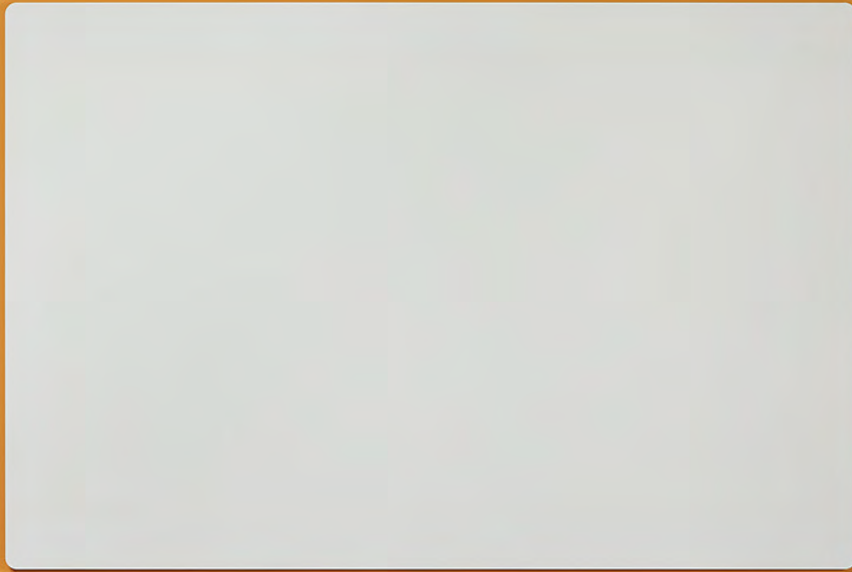

White vitrified steel slate board with 10 mm width rounded corner edges without frame for writing with dry erase markers. Manufactured by water jet cutting and water-repellent wood that give their black lacquered edges a perfect finish. Magnetic surface with lifetime warranty, scratch resistant. Available in gloss and matt finish for projection.

Pizarra de acero vitrificado blanca con esquina redondeada de 10 mm. de grosor sin marco para escritura con rotuladores de borrado en seco. Fabricadas mediante corte de chorro de agua y madera hidrófuga que hace que sus bordes lacados en negro queden con un acabado perfecto. Superficie magnética con garantía de por vida, resistente a rayaduras. Disponible en acabado brillo y mate para proyección.

Tableau en acier émaillé blanc avec coin arrondi de 10 mm. d'épaisseur, sans cadre pour marqueurs effaçables à sec. Fabriqué en bois hydrofuge et découpé au jet d'eau ce qui lui confère des bords laqués noirs d'une finition parfaite. Surface magnétique garantie à vie, résistante aux rayures. Disponible en finition brillante et mate pour la projection.

Sizes

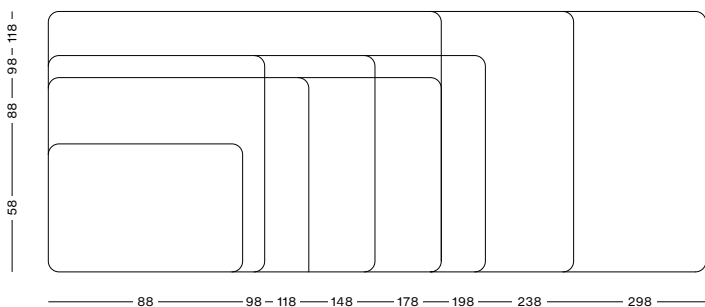

Specs



No frame

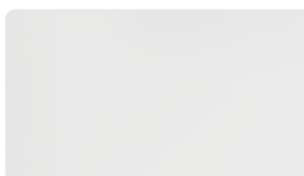

WALL WHITEBOARD ↔ ↵

REF	MATT	↕ ↔	📏	1 cm
7202/10		58x88 cm 22.8x34.6 in	7,66 Kg 16.8 £	0.4 in
7202/1		88x118 cm 34.6x46.4 in	15,58 Kg 34.3 £	
7202/2		88x178 cm 34.6x70 in	23,5 Kg 51.8 £	
7202/3		98x98 cm 38.6x38.6 in	15,41 Kg 33.9 £	
7202/4		98x148 cm 38.6x58.3 in	21,76 Kg 47.9 £	
7202/5		98x198 cm 38.6x80 in	29,11 Kg 64.1 £	
7202/6	7202/6/M	118x148 cm 46.4x58.3 in	26,2 Kg 57.7 £	
7202/7	7202/7/M	118x178 cm 46.4x70 in	31,51 Kg 69.4 £	
7202/8	7202/8/M	118x238 cm 46.4x93.7 in	42,13 Kg 92.8 £	
7202/9	7202/9/M	118x298 cm 46.4x117.3 in	52,75 Kg 116.2 £	



Chameleon Wall



Blackboard with modular white vitrified steel surface. Thanks to it not having any type of frame making its perfect cut using a water jet and water-repellent wood, it makes it possible to add panels as many as required in the area to be covered with an imperceptible union. Available in two sizes and its magnetic surface allows to adapt magnets.

Pizarra con superficie de acero vitrificado blanca modular. Gracias a que no lleva ningún tipo de marco y que su perfecto corte está realizado con chorro de agua y madera hidrófuga, hace que permitan añadirse paneles tanto como sea necesario en el área a cubrir con una unión imperceptible. Disponible en dos alturas y su superficie magnética permite adaptar imanes.

Tableau modulaire avec superficie en acier émaillé blanc. Grâce au fait qu'il n'a pas de cadre et que sa découpe du bois hydrofuge est réalisée au jet d'eau, il est possible d'ajouter autant de panneaux que nécessaire dans la zone à couvrir. La séparation entre chaque panneau est imperceptible. Disponible en deux hauteurs, sa surface magnétique permet d'utiliser des aimants.

Sizes

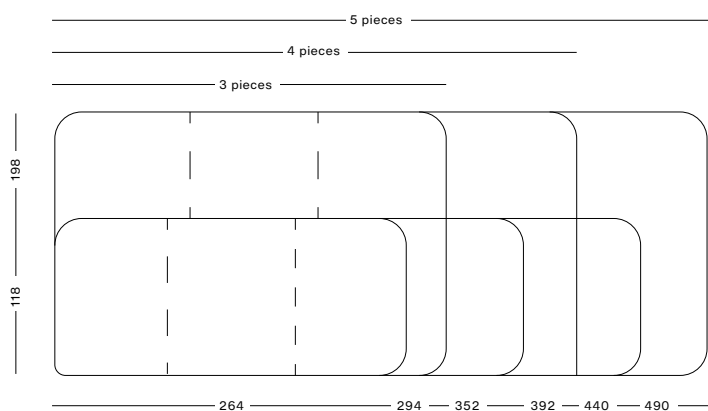

Specs



WALL

WHITEBOARD

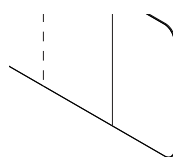

REF	↕ ↔	PANELS	REF	↕ ↔	PANELS	1 cm 0.4 in
7201/1/W3	118x264 cm 46.4x103.9 in	3	7201/5/W3	198x294 cm 77.9x115.7 in	3	
7201/1/W4	118x352 cm 46.4x138.6 in	4	7201/5/W4	198x392 cm 77.9x154.3 in	4	
7201/1/W5	118x440 cm 46.4x173.2 in	5	7201/5/W5	198x490 cm 77.9x192.9 in	5	

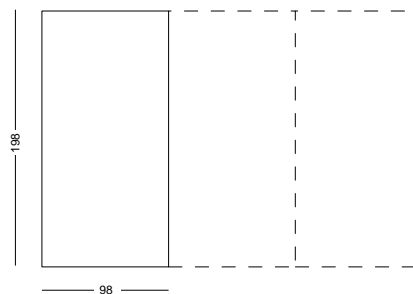
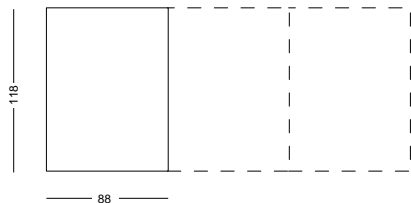

WALL

WHITEBOARD



REF	↕ ↔	PANELS	REF	↕ ↔	PANELS	1 cm 0.4 in
7201/1/W	118x88 cm 46.4x34.6 in		7201/5/W	198x98 cm 77.9x38.6 in		

Chameleon Custom



$$-P_r(1-\cos\varphi); \quad \frac{P_r^3}{EJ} \frac{(1-\cos\alpha)^2}{2};$$
$$\frac{P \cos \varphi}{EJ} \left(\frac{3}{2} a - 2 \sin \alpha + \frac{\sin 2\alpha}{4} \right);$$
$$M_i = -\frac{q x_i^2}{2}; \quad \bar{M}_i = -l \cdot x_i;$$
$$\frac{P_r^2}{EJ} (\alpha - \sin \alpha);$$
$$\varphi = \frac{EJ}{GJ_k}; \quad \frac{m r}{EJ} \frac{\lambda - l}{2} \sin^2 \alpha;$$
$$\frac{n}{EJ} \left(\frac{1+\lambda}{2} a - \frac{\lambda-l}{4} \sin 2\alpha \right);$$

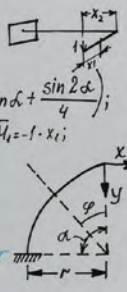

Blackboard with white a vitrified steel surface. Thanks to the fact that it does not carry any type of frame and that its perfect cut is made using a water jet and water-repellent wood, it allows it to be cut with the desired silhouette to cover the necessary area, even save switches, fire extinguishers, push buttons ... Its surface Magnet allows you to adapt magnets.

Pizarra con superficie de acero vitrificado blanca. Gracias a que no lleva ningún tipo de marco y que su perfecto corte está realizado con chorro de agua y madera hidrófuga, hace que permita cortarse con la silueta deseada para cubrir el área necesaria, incluso salvar interruptores, extintores, pulsadores... Su superficie magnética permite adaptar imanes.

Tableau en acier émaillé blanc. Grâce au fait qu'il n'a pas de cadre et que sa découpe du bois hydrofuge est réalisée au jet d'eau, cela permet de découper toutes les formes que vous souhaitez, et ainsi sauver vos interrupteurs, vos extincteurs et autres boutons poussoirs ... Sa surface magnétique vous permet d'utiliser des aimants.

Sizes

CUSTOM

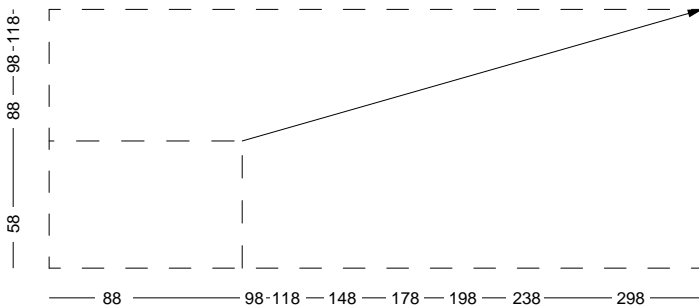

Specs



WALL WHITEBOARD ↔

CUSTOM	REF	↕ ↔	1 cm
100% Custom	7200	Máx. 118x298 cm Max. 46.4x117.3 in	0.4 in

WALL WHITEBOARD ↔

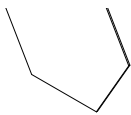
SIX SQUARE	REF	∅	1 cm
	7206/1	60 cm 23.6 in	0.4 in
	7206/2	98 cm 38.6 in	
	7206/3	118 cm 46.5 in	

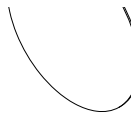
ROUND	REF	∅	1 cm
	7208/1	60 cm 23.6 in	0.4 in
	7208/2	98 cm 38.6 in	
	7208/3	118 cm 46.5 in	



SIX SQUARE

ROUND

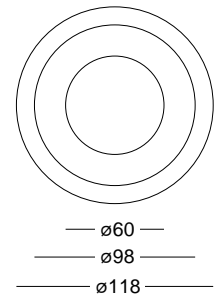
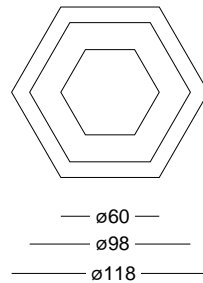

Chameleon Print

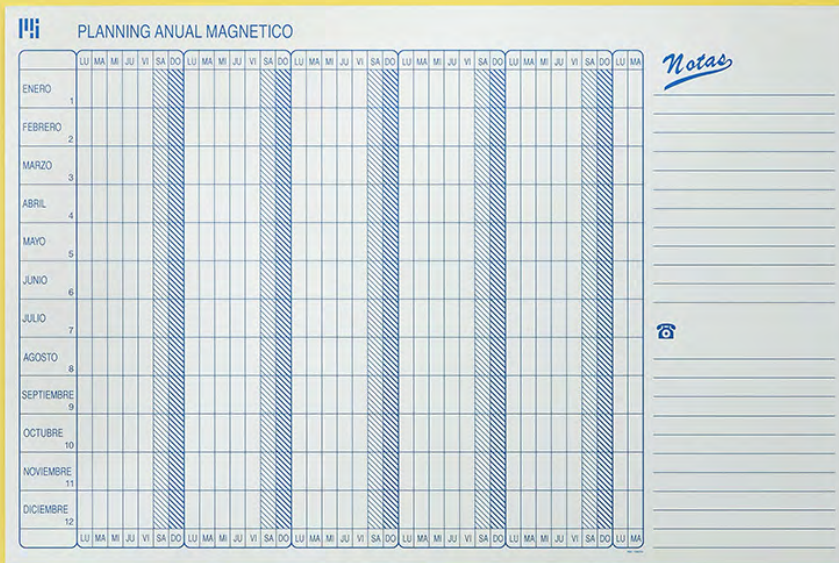

Blackboard with a white vitrified steel surface that allows, through sublimated, to print the desired grid or photo .. Due to it not having any type of frame and that its perfect cut is made using a water jet and water-repellent wood, it allows cutting the desired silhouette. Its magnetic surface allows you to adapt magnets.

Pizarra con superficie de acero vitrificado blanca que permite mediante sublimación, imprimir la retícula o la foto deseada.. Gracias a que no lleva ningún tipo de marco y que su perfecto corte está realizado con chorro de agua y madera hidrófuga, hace que permita cortarse con la silueta deseada. Su superficie magnética permite adaptar imanes.

Tableau noir avec surface en acier blanc émaillé qui permet par sublimation, imprimer la grille/planning ou la photo souhaitée. Grâce au fait qu'il n'a pas d'encadrement et que sa coupe parfaite est réalisée avec jet d'eau et bois hydrofuge, cela permet d'être coupé avec la silhouette souhaitée. Sa surface magnétique permet d'utiliser les aimants.

Sizes

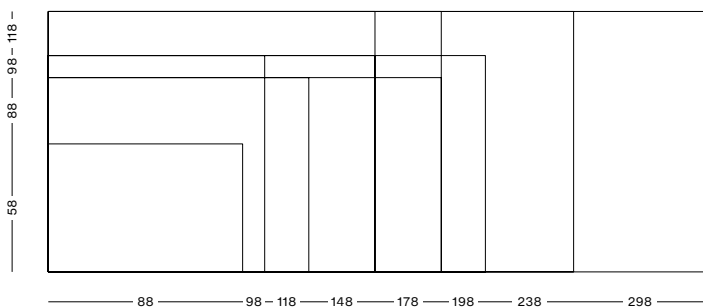

Specs



No frame



WALL		WHITEBOARD		↔	
CUSTOM	AV	MATT	↕ ↔	1 cm	
100% Custom	7200/P2/B	7200/P2/M	Máx. 118x298 cm Max. 46.4x117.3 in	0.4 in	



Chameleon Mobile & Momentum



The Chameleon range of easel whiteboards double sided made of enamelled steel can be used with dry erase markers. Available in a mobile version with castors and a tubular base with leather handles and also a light weight model for wall mounting. Both are available in 3 colors, they are magnetic and allow you to adapt magnets to your surfaces.

Gama de pizarras blancas de caballete Chameleon de doble cara, fabricadas en acero vitrificado rotulable con rotuladores de borrado en seco. Disponible en versión provista de ruedas y base tubular con asa de cuero y un modelo muy liviano para apoyar en la pared. Ambas disponibles en 3 colores, son magnéticas y permite adaptar imanes sobre su superficie.

Gamme de tableaux blancs Chameleon double face de type chevalet en acier émaillé pour marqueurs effaçables à sec. Disponible en version avec roues et base tubulaire, une poignée en cuir et un autre modèle très léger à appuyer contre le mur. Les deux sont disponibles en 3 couleurs, sont magnétiques et vous permettent d'utiliser des aimants.

Mobile

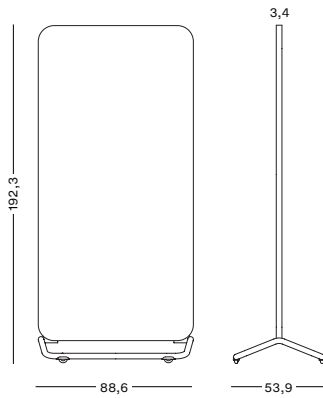

Momentum

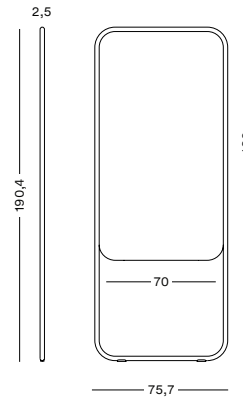

Specs



WHITEBOARD → ←

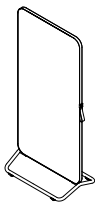

REF
7215/1

↕ ↔
192,3x88,6 cm
75x34.9 in

⚖️
35 Kg
77.1 £

53,9 cm
21.2 in

Specs

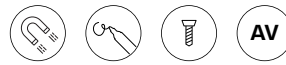

WHITEBOARD → ←



REF
7216/1

↕ ↔
190,4x75,7 cm
75x29.8 in

⚖️
15 Kg
33 £

2,5 cm
1 in



In essence, glass is a material that allows multiple uses, formats, colors and finishes. We have made it a blackboard to be able to write and erase, transforming its surface into a subdued color finish that allows perfect visibility and subsequent easy cleaning. In addition, our range of colored tempered glass whiteboards is magnetic and will hold notes using magnets.

El cristal en esencia es un material que permite múltiples usos, formatos, colores y acabados. Nosotros hemos hecho de él una pizarra para poder escribir y borrar transformando su superficie en un acabado de color tenue que permite una perfecta visibilidad y posterior limpieza. Además, nuestra gama de pizarras de cristal laminado de colores, es magnética para poder sujetar notas mediante imanes.

Le verre par essence est un matériau qui permet de multiples utilisations, formats, couleurs et finitions. Nous en avons fait un tableau pour pouvoir écrire et effacer, transformant sa surface en une finition de couleur tamisée qui permet une visibilité et un nettoyage parfait. De plus, notre gamme de tableaux en verre trempé coloré est magnétique pour maintenir des notes à l'aide d'aimants.





Glass Board

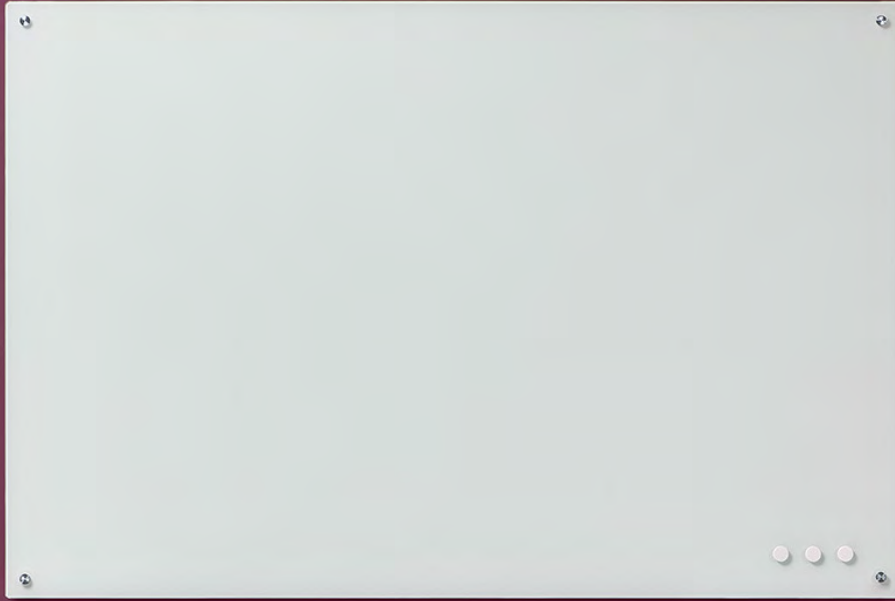

4mm width frameless white laminated glass magnetic whiteboard. Surface suitable for dry erase markers. It incorporates elements for wall mounting, a 30 cm box that holds markers, 5 neodymium magnets and a magnetic eraser.

Pizarra magnética de cristal laminado blanco sin marco de 4 mm. de grosor. Superficie apta para rotuladores de borrado en seco. Incorpora elementos de fijación a pared, cajetín de 30 cm reposa rotuladores, 5 imanes de neodimio y un borrador magnético.

Tableau blanc magnétique en verre stratifié blanc sans cadre de 4 mm. d'épaisseur. Surface adaptée aux marqueurs effaçables à sec. Inclus kit de fixation mural, un auget de 30 cm pour marqueurs, 5 aimants néodyme et un effaceur magnétique.

Sizes

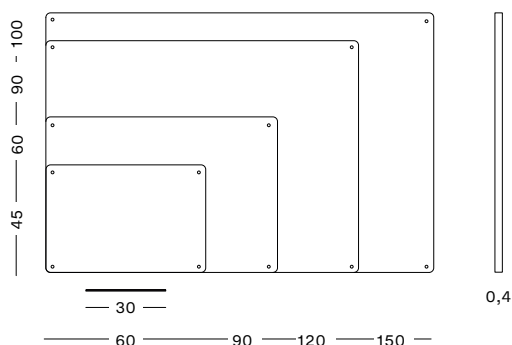

Specs



No frame

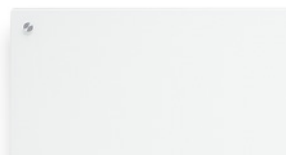

WALL	WHITEGLASS			
	REF	$\updownarrow \leftrightarrow$		0,4 cm 0.1 in
	728/1	45x60 cm 17,7x23,6 in	8 Kg 17.6 £	
	728/2	60x90 cm 23,6x35,4 in	13 Kg 28.6 £	
	728/3	90x120 cm 35,4x47,2 in	19 Kg 41.9 £	
	728/4	100x150 cm 39,3x59 in	25 Kg 55.1 £	



Color Glass Board



4mm + 1mm width metal magnetic glass board, in soft colors that improve sharpness in writing and erasing. Surface suitable for writing and erasing with dry erase markers. It allows you to adapt and use magnets and includes fittings.

Pizarra magnética de cristal laminado de 4mm + 1mm de chapa, en colores tenues que mejoran la nitidez en la escritura y el borrado. Superficie apta para escritura y borrado con rotuladores de borrado en seco. Permite adaptar imanes e incluyen los elementos de fijación.

Tableau en verre stratifié magnétique de 4mm + 1mm de tôle, disponible dans des couleurs tamisées qui améliorent la netteté de l'écriture et facilitent l'effacement. Surface adaptée à l'écriture avec des marqueurs effaçables à sec. Il permet l'usage d'aimants et comprend les éléments de fixation.



Color Glass Board

Size

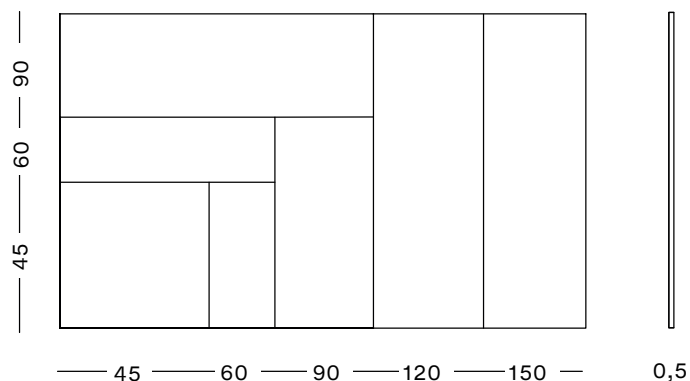

Colour

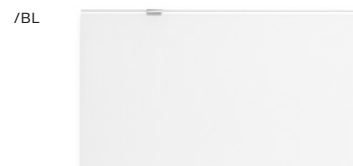

Specs



WALL	GLASS							↕ ↔	📏	↗ ↖
	REF	●	●	●	●	●	●			0,5 cm 0.1 in
	728/CO/1	/BL	/AM	/AZ	/NJ	/RS	/VD	45x45 cm 17.7x17.7 in	6 Kg 13,2 £	
	728/CO/2	/BL	/AM	/AZ	/NJ	/RS	/VD	45x60 cm 17.7x23.6 in	8 Kg 17,6 £	
	728/CO/3	/BL	/AM	/AZ	/NJ	/RS	/VD	45x90 cm 17.7x35.4 in	12 Kg 26,4 £	
	728/CO/4	/BL	/AM	/AZ	/NJ	/RS	/VD	60x60 cm 23.6x23.6 in	10,6 Kg 23,3 £	/RS
	728/CO/5	/BL	/AM	/AZ	/NJ	/RS	/VD	60x90 cm 23.6x35.4 in	16 Kg 35,2 £	
	728/CO/6	/BL	/AM	/AZ	/NJ	/RS	/VD	90x90 cm 35.4x35.4 in	24 Kg 52,9 £	
	728/CO/7	/BL	/AM	/AZ	/NJ	/RS	/VD	90x120 cm 35.4x47.2 in	32 Kg 70,5 £	
	728/CO/8	/BL	/AM	/AZ	/NJ	/RS	/VD	90x150 cm 35.4x59 in	40 Kg 88,1 £	/VD

Accessories

Neodymium 5 magnets pack (9.8 in)
 Pack 5 imanes de neodimio (2,5 cm)
 Pack de 5 aimants néodyme (2,5 cm)

9016



Glass Board Magnetic Eraser
 Borrador magnético pizarra de cristal
 Gomme magnétique tableau en verre

7016

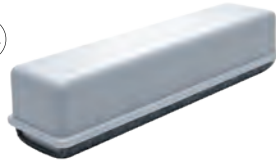

Adhesive Pen Tray 20cm
 Bandeja de 20cm adhesiva
 Auget adhésif 20 cm

7280



Limit Board



Limit white vitrified steel partition board for writing and erasing with dry erase markers. Aluminum frame available in matt silver, anthracite and white, and matching metallic trapezoidal feet. Magnetic surface suitable for the use of magnets on both sides. Ideal for separating work environments, in coworking and offices as well as in collaborative or training spaces.

Pizarra mampara Limit de acero vitrificado blanca para escritura y borrado con rotuladores de borrado en seco. Marco de aluminio disponible en plata mate, antracita y blanco, y pies trapecoidales metálicos a juego. Superficie magnética apta para uso de imanes en las dos caras. Ideal para separar ambientes de trabajo, en coworkings y oficinas, así como en espacios colaborativos o de formación.

Cloison Tableau Limit en acier émaillé blanc pour marqueurs effaçables à sec. Structure en aluminium disponible en argent mat, anthracite et blanc, et pieds trapézoïdaux métalliques assortis. Surface magnétique double face. Idéal pour séparer les environnements de travail, dans les coworkings, les bureaux, ainsi que dans les espaces collaboratifs ou de formation.



Limit Board

Sizes

Aluminium frame

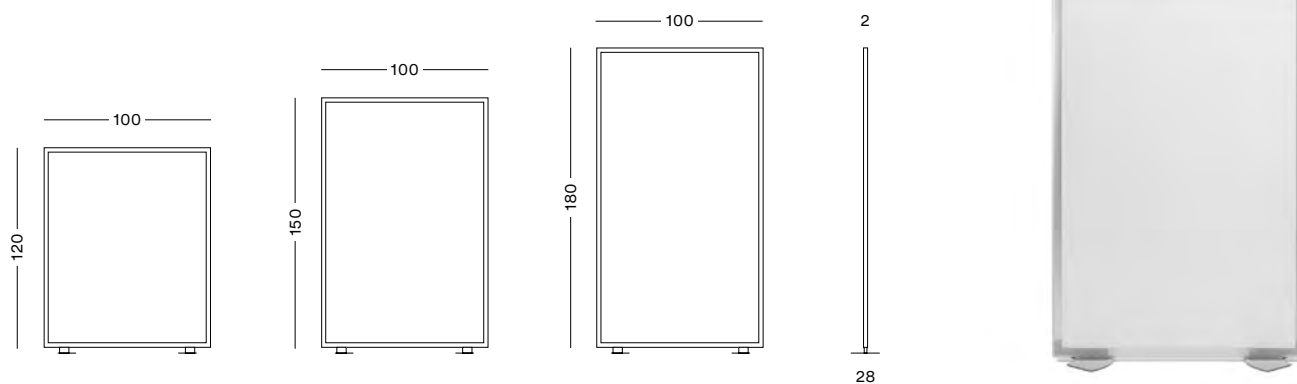

Specs



Colour frames

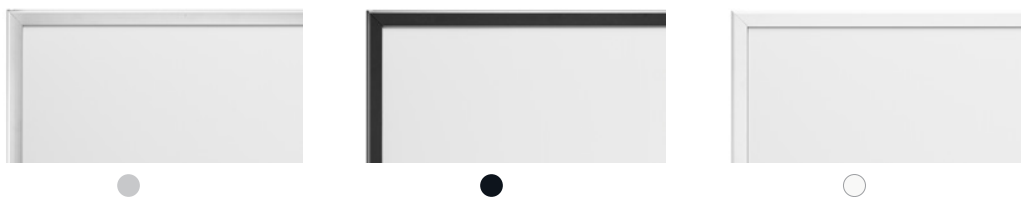

WHITEBOARD

ACCESSORIES

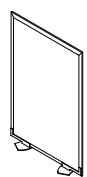

300/1/PI



300/1/PI/AN



300/1/PI/BL



120x100 cm
47.2x39.3 in



21 Kg
46,29 £

2 cm
0.78 in

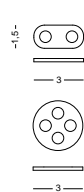

REF

300/K



2x5 cm
0.78x1.96 in



2

300/K/4

5x5 cm
1.96x1.96 in

4

300/2/PI

300/2/PI/AN

300/2/PI/BL

150x100 cm
59.05x39.3 in

26,1 Kg
57,54 £

300/3/PI

300/3/PI/AN

300/3/PI/BL

180x100 cm
70.8x39.3 in

31,3 Kg
69 £

Other finishes

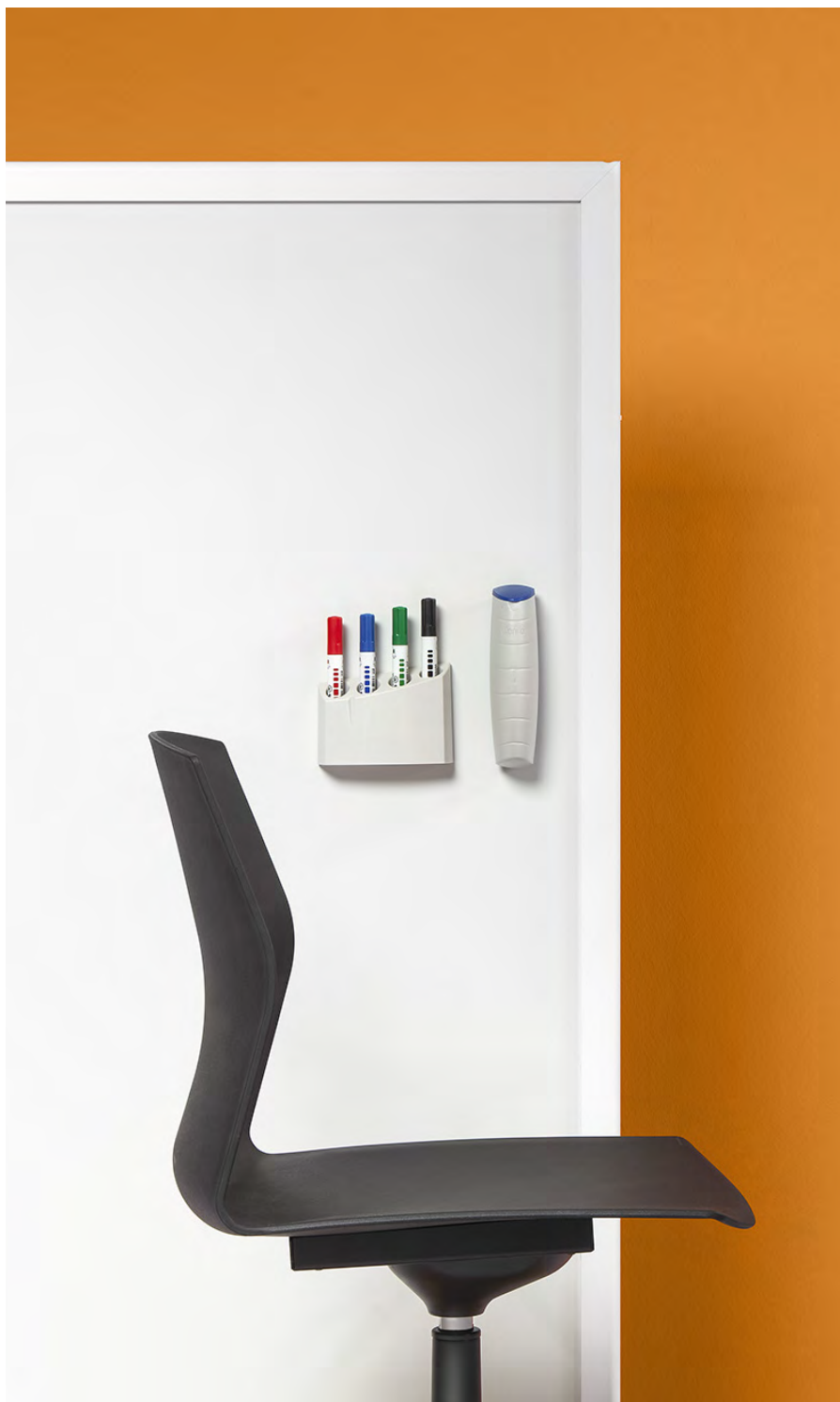

Acrylic Panel → [VIEW ON PAGE: 194](#)



Acoustic Panel → [VIEW ON PAGE: 148](#)

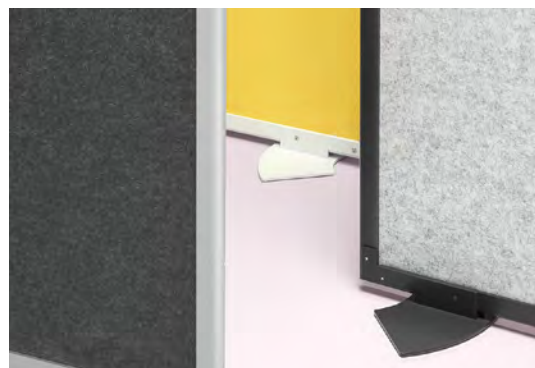

Antibacterial Panel → [VIEW ON PAGE: 198](#)



Ten Limit Board



Ten Limit blackboard in white vitrified steel for writing and erasing with dry erase markers. Aluminum profile frame available in matt silver, anthracite and white and legs with castors made of cast aluminum. Magnetic surface suitable for the use of magnets on both sides. Ideal for separating work environments, in coworking and offices as well as in collaborative or training spaces.

Mampara pizarra Ten Limit de acero vitrificado blanca para escritura y borrado con rotuladores de borrado en seco. Marco de perfil de aluminio disponible en plata mate, antracita y blanco, y pies con ruedas fabricados de fundición de aluminio. Superficie magnética apta para uso de imanes en las dos caras. Ideal para separar ambientes de trabajo, en coworkings y oficinas, así como en espacios colaborativos o de formación.

Cloison Tableau Ten Limit en acier émaillé blanc pour marqueurs effaçables à sec. Cadre profilé en aluminium disponible en argent mat, anthracite et blanc, piétement avec roulettes en fonte d'aluminium. Surface magnétique double face. Idéal pour séparer les environnements de travail, dans les coworkings et les bureaux, ainsi que dans les espaces collaboratifs ou de formation.

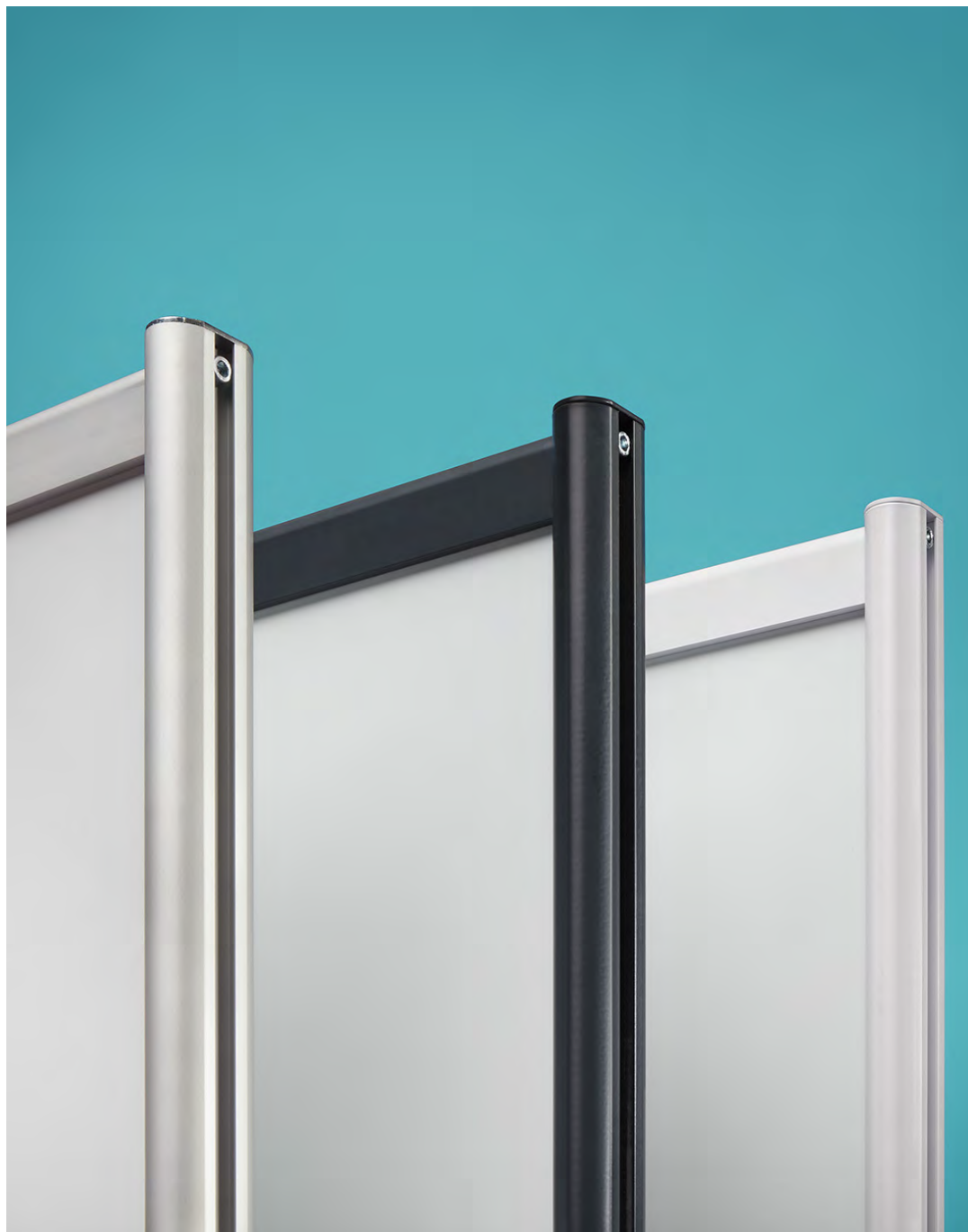

Ten Limit Board

Sizes

Aluminium frame

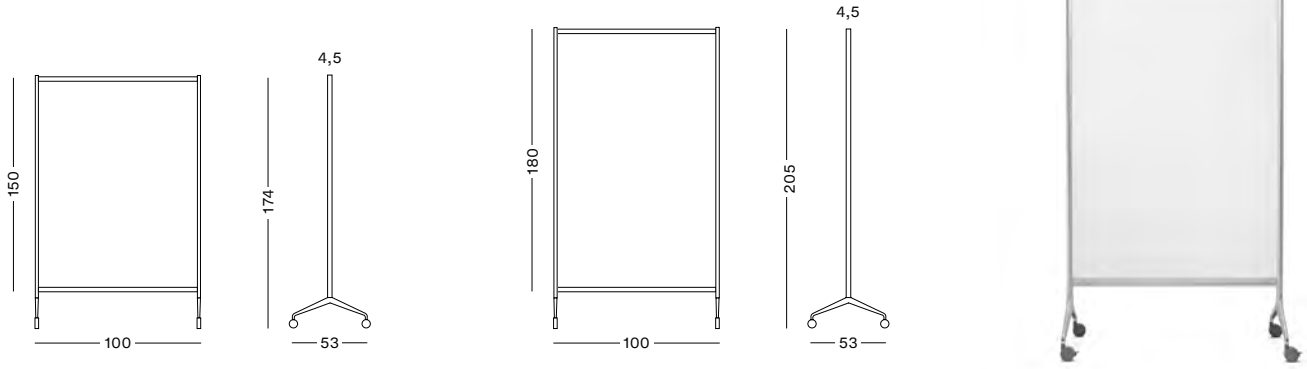

Specs



Colour frames

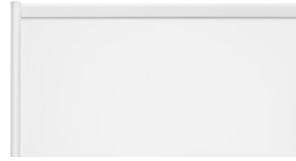

WHITEBOARD

BOARD

SUPPORT



TL/150/PI



TL/150/PI/AN



TL/150/PI/BL

BOARD
150x100 cm
59,05x39,3 in



174 cm
68.5 in



19 Kg
41.9 £

4,5 cm
1.7 in

53 cm
20.8 in

TL/180/PI

TL/180/PI/AN

TL/180/PI/BL

BOARD
180x100 cm
70,8x39,3 in

205 cm
80.7 in

19.5 Kg
43.8 £



Flipcharts



Lacquered easel whiteboards for writing with dry erase markers. Magnetic surfaces suitable for magnets. Metal structure with tripod or base with castors in each version. They include a box to hold markers and a paper block holder. The ref. 709 / N includes two arms to triple the exposure area.

Pizarras blancas lacadas de caballete para escritura con rotuladores de borrado en seco. Superficies magnéticas aptas para imanes. Estructura metálica con trípode o base con ruedas en cada caso. Incluyen cajetín reposa rotuladores y pinza portablock de papel. La ref. 709/N incluye dos brazos para triplicar la superficie de exposición.

Tableaux chevalets laqués blancs pour marqueurs effaçables à sec. Surfaces magnétiques adaptées aux aimants. Structure métallique avec trépied ou base avec roues. Comprend un auget pour marqueurs et un support de bloc de papier. La réf. 709 / N comprend deux bras extensibles pour tripler la superficie d'exposition.

Sizes

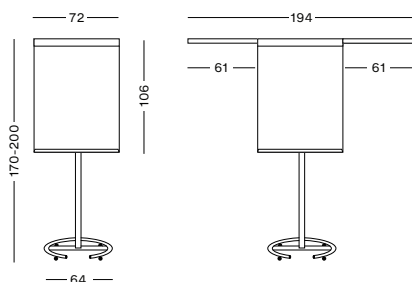

Sizes

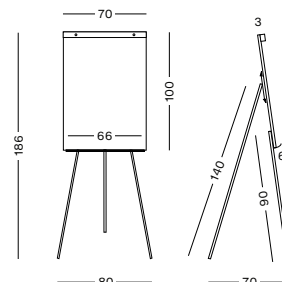

Specs



WRITEBOARD	Ø
REF 709/N SIZE MAX. 200/170x72 cm MAX. 78.7/66.9x28.3 in WEIGHT 18 Kg 39.6 £	64 cm 25.2 in

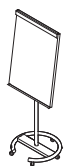

Specs



WRITEBOARD	↔
REF 711/N SIZE 168x80 cm 66.1x31.5 in WEIGHT 10 Kg 22.6 £	70 cm 27.5 in



Screen board



Slate board partition screen for workstations in vitrified steel. Surface for writing with dry erase markers, magnetic for use of magnets and on the back it incorporates, in the same measure as the blackboard, a sound-absorbing panel made of recycled PET in gray. Allows placement of notes with thumbtacks. The set is fixed using a set of brackets included.

Mampara pizarra separadora para puestos de trabajo de acero vitrificado. Superficie para escritura con rotuladores de borrado en seco, magnética para uso de imanes y en la parte posterior incorpora de la misma medida que la pizarra un panel fonoabsorbente de PET reciclado de color gris. Permite sujeción de notas mediante chinchetas. El conjunto se fija mediante juego de pinzas incluidas.

Cloison séparatrice pour poste de travail en acier émaillé. Une face d'écriture pour marqueurs effaçables à sec et magnétique pour l'utilisation d'aimants et au dos un panneau insonorisant en PET recyclé de couleur gris. Permet l'affichage de notes. L'ensemble est fixé à l'aide d'un jeu de pinces incluses.

Sizes

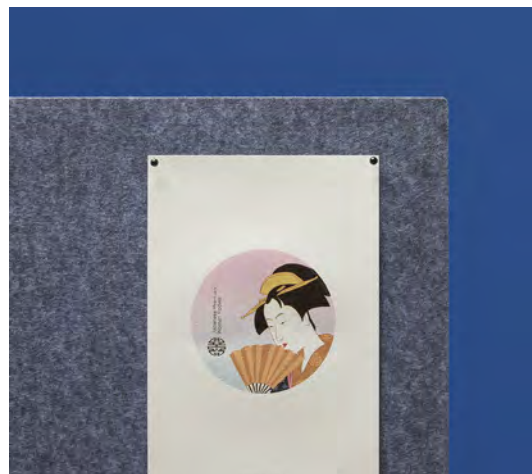
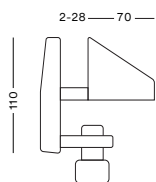
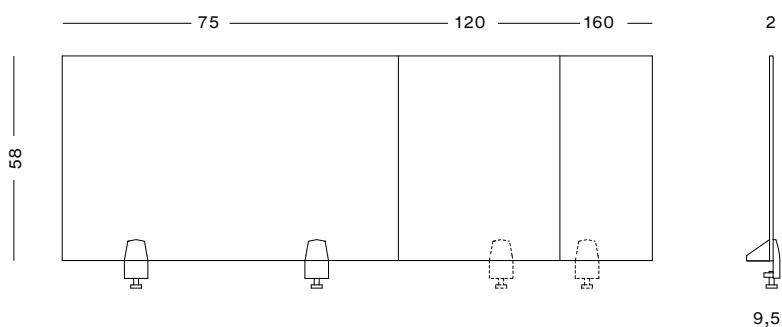

Specs



	WRITEBOARD	BOARD	SUPPORT	
REF	↕ ↔	⚖	2 cm	9,5 cm
EP/MP/58/75	58x75 cm 22.8x29.5 in	9,7 Kg 21.4 £	0.78 in	3.74 in
EP/MP/58/120	58x120 cm 22.8x47.2 in	12,7 Kg 28 £		
EP/MP/58/160	58x160 cm 22.8x62.9 in	16,5 Kg 36.4 £		



Supports



Set of Brackets with castors for the entire range of whiteboards and bulletin boards. Made in two versions, iron and aluminum, and available in matt silver, and or lacquered in anthracite and white. Wooden T-shaped feet are also available. All supports include 4 swivel castors 2 of which are equipped with brakes. The Y2 base is made of cast aluminum.

Juego de soportes con ruedas para toda la gama de pizarras y tableros de anuncios. Fabricados en 2 calidades, de hierro y aluminio, y disponibles en plata mate, y lacados en antracita y blanco. También se dispone de pies en forma de T de madera. Todos los soportes incluyen 4 ruedas giratorias 2 de ellas provistas de freno. La base Y2 es de fundición de aluminio.

Ensemble de supports à roulettes pour toute la gamme de tableaux blancs et d'affichage. Fabriqué en 2 finitions, métal et aluminium, disponible en argent mat, laqué anthracite ou blanc. Les pieds "T" sont également disponibles en bois. Tous les supports comprennent 4 roues pivotantes, dont 2 équipés de freins. La base Y2 est en fonte d'aluminium.

Size

WOOD

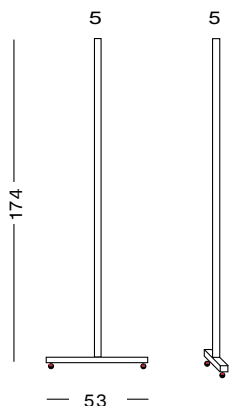

IRON

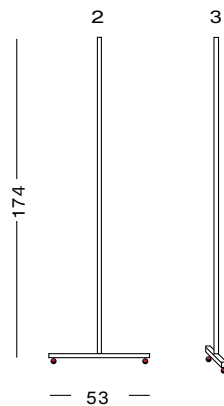

ALUMINIUM

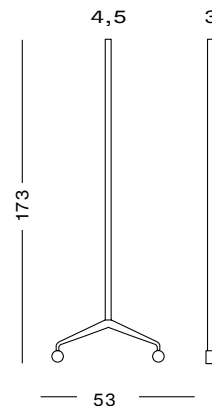

Specs



Available for

720 + 725

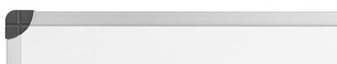

730 + 730/A



765



760



Z/720



Z/730



Z/765



Z/760



R-PET

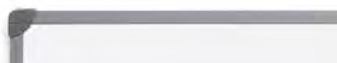

724

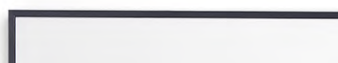

760 R-PET



765 R-PET



Supports

Iron · Support T · Colour

Wood



WOOD

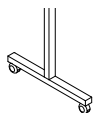

REF
770/1



/AN /BL

↕ ↔
174x53 cm
68.5x20.8 in

📦
7 Kg
15.4 £

53 cm
68.5 in

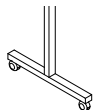

REF
770/1/WO

WOOD FOR
SLIM BOARD

↕ ↔
174x53 cm
68.5x20.8 in

📦
7 Kg
15.4 £

Compatible boards

FOR WHITEBOARD

FOR CHALKBOARD

FOR PINBOARD

FOR PINBOARD COLORS

Slim Board

→ VIEW ON PAGE: 16

→ VIEW ON PAGE: 102

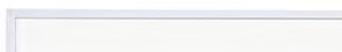

Classic & R-Pet Board

→ VIEW ON PAGE: 24, 28 & 50

→ VIEW ON PAGE: 108 & 112

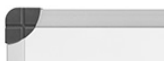

Aluminium · Support Y2 · Colour

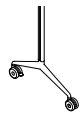

REF	●	●	○	↕ ↔	📏
Y2/80/R		/AN	/BL	173x80 cm 68.1x31.4 in	5 Kg 11 £
Y2/120/R		/AN	/BL	173x120 cm 68.1x47.2 in	6 Kg 13.2 £
Y2/150/R		/AN	/BL	173x150 cm 68.1x6.5 in	6,5 Kg 14.3 £
Y2/175/R		/AN	/BL	173x175 cm 68.1x68.8 in	7 Kg 15.4 £
Y2/200/R		/AN	/BL	173x200 cm 68.1x78.7 in	7,5 Kg 16.5 £

53 cm
68.5 in

Compatible boards

FOR WHITEBOARD

FOR CHALKBOARD

FOR PINBOARD

FOR PINBOARD COLORS

Slim Board

→ VIEW ON PAGE: 16

→ VIEW ON PAGE: 102



Classic & R-Pet Board

→ VIEW ON PAGE: 24, 28 & 50

→ VIEW ON PAGE: 108 & 112



Zenit Board

→ VIEW ON PAGE: 40

→ VIEW ON PAGE: 116



Accessories

Magnetic eraser "Design"
Borrador magnético "Design"
Effaceur magnétique "Design"

7015



Plastic eraser
Borrador de plástico
Feutrine pour effaceur

7014



Magnetic eraser
Borrador magnético
Effaceur magnétique

7006

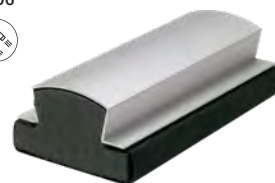

7015 eraser felt refills
Recambio para borrador 7015
Feutrine pour effaceur 7015

7015/1

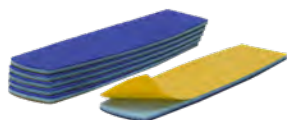

5 u.

7014 eraser felt refills
Recambio para borrador 7014
Feutrine pour effaceur 7014

7014/1



2 u.

Eraser
Borrador
Effaceur

7012



Whiteboard markers
Rotuladores de pizarra
Marqueurs effaçables à sec

7005
7005/12



4 u. - 10 u.

Whiteboard cleaner spray (200 ml)
Aerosol para pizarras (200 ml)
Spray nettoyant (200 ml)

7008



7006 and 7012 eraser felt refills
Recambio para borrador 7006 y 7012
Feutrine pour effaceur 7006 et 7012

7006/1

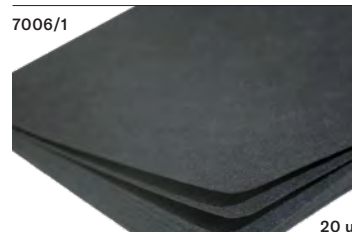

20 u.

Magnetics marker holder
Portarrotuladores magnéticos
Porte marqueurs magnétiques

7019



4 Markers. Cleaning liquid 50 ml.
OVAL magnetic eraser. Eraser replacement
felts. Pack of 10 magnets ø20mm.

KIT/E



4 Markers. Cleaning liquid 200 ml.
Magnetic eraser. Eraser replacement felts.
Pack 10 magnets ø20 mm.
Magnetic marker rest.

KIT/T



Pad of plain paper 90 x 60 cm
Bloc de papel liso 90 x 60 cm
Recharge papier uni 90 x 60 cm

7001



25 sheets

Pad holder 7 x 69 cm
Pinza portablock 7 x 69 cm
Pince papier 7 x 69 cm

7002



Magnetic pad holder 6 x 65 cm
Pinza portablock magnética 6 x 65 cm
Pince papier magnétique 6 x 65 cm

7002/M



100, 30 cm Pen Tray
Cajetín de 100, 30 cm
Porte-marqueurs de 100, 30 cm

7003
7003/30



Round magnets ø2, ø2.5, ø3.2 cm
Imanes redondos ø2, ø2.5, ø3.2 cm
Aimants ronds ø2, ø2.5, ø3.2 cm

9002
9003
9004



6 u.

Round magnets ø0,9 cm
Imanes redondos ø0,9 cm
Aimants ronds ø0,9 cm

9010



20 u.

Neodymium 5 magnets pack (9.8 in)
Pack 5 imanes de neodimio (2,5 cm)
Pack de 5 aimants néodyme (2,5 cm)

9016



Glass Board Magnetic Eraser
Borrador magnético pizarra de cristal
Gomme magnétique tableau en verre

7016

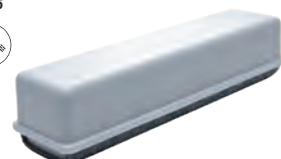

Adhesive Pen Tray 20cm
Bandeja de 20cm adhesiva
Augef adhesif 20 cm

7280



White chalk box
Caja tizas blancas
boîte de craies blanches

7013/B
(10 Uts.)



Colored chalk box
Caja tizas de colores
Boîte de craies colorées

7013/C
(10 Uts.)



Pinboards

Slim Pinboard	102
Bulletin Board	108
R · PET Pinboard	112
Zenit Pinboard	116
Basic Pinboard	120
Chameleon Pinboard	122
Chameleon Geometric Pinboard	124
Pinboards Showcase	126
Magnetic Showcase	130
Outdoor Showcase	132
Outdoor Telescopic Showcase	134

Having your notes, photos, drawings or your favorite texts on view makes the drawing board just as important. That visual reminder, that pending task, that moment captured by a camera in the form of a photo, or that drawing of your child who makes you feel special deserves a good place, and at work or in school, a report, a notification, academic notes, or the poster of an event need a place in a visual area for all eyes to see. With or without glazing and of course in your favorite colour or wherever your team of interior designers decides is best in the place where it's to be located.

Tener a la vista tus notas, fotos, dibujos o tus textos preferidos hace que su soporte sea cuanto menos, igual de importante. Ese recordatorio visual, esa tarea pendiente, aquel instante captado por una cámara en forma de foto, o ese dibujo de tu hijo que te hace sentir especial, merece un buen espacio, y en la empresa o en la escuela, un informe, una notificación, unas notas académicas, o el póster de algún evento necesitan de su espacio en una zona visual al abasto de todas las miradas. Con o sin acristalar y por supuesto en tu color preferido o en el que tu equipo de interioristas decida cual queda mejor en el espacio donde se vaya a ubicar.

"Avoir vos notes, photos, dessins ou vos textes préférés à la vue rend leur support d'autant plus important. Ce rappel visuel, cette tâche en attente, ce moment capturé par un appareil photo, ou ce dessin de votre enfant qui vous fait sentir spécial mérite un bon espace, et dans l'entreprise ou à l'école. Un rapport, une notification, des notes académiques ou l'affiche d'un événement ont aussi besoin d'une place dans un espace visuel pour être vu par tout le monde. Avec ou sans vitrage et bien sûr de la couleur de votre choix ou de celle de votre équipe d'architectes d'intérieur, vous pourrez l'adapter parfaitement à votre espace."





Slim Pinboard



Upholstered notice board or natural visible cork, framed with anodized Slim aluminum profile matt silver or lacquered in white or anthracite. Available to fix both on the wall, or mobile on castors with brakes. Notes and notices can be attached to its surface using pins or thumbtacks. 5 mm thick cork. Choice of textiles in 12 colors.

Tablero de anuncios tapizado o corcho visto natural, enmarcado con perfil de aluminio Slim anodizado plata mate o lacado en blanco o antracita. Disponibles para fijarse tanto en la pared, como sobre soportes móviles con ruedas y freno. Sobre su superficie se pueden fijar notas, avisos, comunicados etc... mediante agujas o chinchetas. Corcho de 5 mm de grosor. Gama a elegir de textil en 12 colores.

Tableau d'affichage tapissé ou en liège naturel, encadré d'un profil mince en aluminium anodisé argent mat, laqué blanc ou gris anthracite. Disponible pour le fixer aussi bien au mur que sur des supports mobiles avec roues et frein. Les notes, avis, communiqués etc... peuvent être fixés sur la surface à l'aide d'aiguilles ou de punaises. Liège de 5 mm d'épaisseur. Tissu à choisir entre 12 coloris.

Sizes



Specs



Cork



Textiles colours



Slim PinBoard

Wood frame

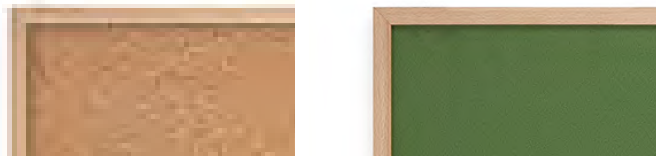

WALL



CORK

REF	↕ ↔	📏
764/10/C/WO	40x60 cm 15.7x23.6 in	2,56 Kg 5.6 £
764/1/C/WO	60x80 cm 23.6x31.5 in	5,12 Kg 11.3 £
764/2/C/WO	80x100 cm 31.5x39.3 in	8,5 Kg 18.8 £
764/3/C/WO	100x120 cm 39.3x47.2 in	12.8 Kg 28.22 £
764/4/C/WO	100x150 cm 39.3x60 in	16 Kg 35.3 £
764/5/C/WO	100x175 cm 39.3x70 in	18.6 Kg 42 £
764/6/C/WO	100x200 cm 39.3x78.7 in	25,6Kg 56.5 £

TEXTILES



REF	TEXTIL COLOUR	↕ ↔	📏	3 cm
764/10/WO	● /NG ● /BD	40x60 cm 15.7x23.6 in	2,56 Kg 5.6 £	1.1 in
764/1/WO	● /GR ● /AC	60x80 cm 23.6x31.5 in	5,12 Kg 11.3 £	
764/2/WO	● /CR ● /AZ	80x100 cm 31.5x39.3 in	8,5 Kg 18.8 £	
764/3/WO	● /OC ● /VM	100x120 cm 39.3x47.2 in	12.8 Kg 28.22 £	
764/4/WO	● /NJ ● /VC	100x150 cm 39.3x60 in	16 Kg 35.3 £	
764/5/WO	● /RJ ● /VD	100x175 cm 39.3x70 in	18.6 Kg 42 £	
764/6/WO		100x200 cm 39.3x78.7 in	25,6Kg 56.5 £	

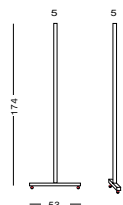

SUPPORT

AVAILABLE SIZES



REF	↕ ↔	↕	📏	53 cm
770/1/WO/1	80x100 cm 31.5x39.3 in	174 cm 68.5 in	7 Kg 15.4 £	20.9 in
770/1/WO/2	100x120 cm 39.4x47.2 in			
770/1/WO/3	100x150 cm 39.4x60 in			
770/1/WO/4	100x175 cm 39.4x70 in			
770/1/WO/5	100x200 cm 39.4x78.7 in			

Aluminium frames

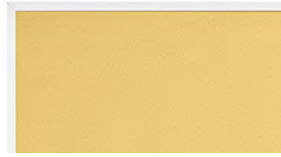

WALL



						RAIL	T	Y2	
764/10/C	764/10/C/AN	764/10/C/BL	40x60 cm 15.7x23.6 in	2,5 Kg 5.6 £					2,3 cm 0.9 in
764/1/C	764/1/C/AN	764/1/C/BL	60x80 cm 23.6x31.5 in	5,1 Kg 11.3 £					
764/2/C	764/2/C/AN	764/2/C/BL	80x100 cm 31.5x39.3 in	8,5 Kg 18.8 £	•	•	•		
764/3/C	764/3/C/AN	764/3/C/BL	100x120 cm 39.3x47.2 in	12,8 Kg 28.22 £	•	•	•		
764/4/C	764/4/C/AN	764/4/C/BL	100x150 cm 39.3x60 in	16 Kg 35.3 £	•	•	•		
764/5/C	764/5/C/AN	764/5/C/BL	100x175 cm 39.3x70 in	18,6 Kg 42 £	•	•	•		
764/6/C	764/6/C/AN	764/6/C/BL	100x200 cm 39.3x78.7 in	25,6 Kg 56.5 £					
764/7/C	764/7/C/AN	764/7/C/BL	100x250 cm 39.3x98.4 in	27Kg 59.5 £					

WALL



				TEXTIL COLOUR			RAIL	T	Y2	
764/10	764/10/AN	764/10/BL	/NG /BD	40x60 cm 15.7x23.6 in	2,5 Kg 5.6 £					2,3 cm 0.9 in
764/1	764/1/AN	764/1/BL	/GR /AC	60x80 cm 23.6x31.5 in	5,1 Kg 11.3 £					
764/2	764/2/AN	764/2/BL	/CR /AZ	80x100 cm 31.5x39.3 in	8,5 Kg 18.8 £	•	•	•		
764/3	764/3/AN	764/3/BL	/OC /VM	100x120 cm 39.3x47.2 in	12,8 Kg 28.22 £	•	•	•		
764/4	764/4/AN	764/4/BL	/RJ /VD	100x150 cm 39.3x60 in	16 Kg 35.3 £	•	•	•		
764/5	764/5/AN	764/5/BL		100x175 cm 39.3x70 in	18,6 Kg 42 £	•	•	•		
764/6	764/6/AN	764/6/BL		100x200 cm 39.3x78.7 in	25,6 Kg 56.5 £					
764/7	764/7/AN	764/7/BL		100x250 cm 39.3x98.4 in	27Kg 59.5 £					

Slim board

Iron support



SUPPORT

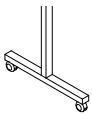

770/1/GR



770/1/AN



770/1/BL

AVAILABLE SIZES

↕ ↔
 80x100 cm
 31.5x39.3 in
 100x120 cm
 39.3x47.2 in
 100x150 cm
 39.3x60 in
 100x175 cm
 39.3x70 in
 120x200 cm
 47.2x78.7 in

↕
 174 cm
 68.5 in



7 Kg
 15.4 £



53 cm
 20.9 in



Aluminium support

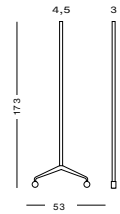

SUPPORT

AVAILABLE SIZES

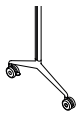
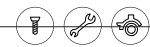

	●	●	○	↕ ↔	↕	⚖
Y2/80/R	Y2/80/R/AN	Y2/80/R/BL	80x100 cm 31.5x39.3 in	173 cm 68.1 in	5 Kg 11 £	
Y2/120/R	Y2/120/R/AN	Y2/120/R/BL	100x120 cm 39.3x47.2 in	173 cm 68.1 in	6 Kg 13.2 £	
Y2/150/R	Y2/150/R/AN	Y2/150/R/BL	100x150 cm 39.3x60 in	173 cm 68.1 in	6,5 Kg 14.3 £	
Y2/200/R	Y2/200/R/AN	Y2/200/R/BL	120x200 cm 47.2x78.7 in	173 cm 68.1 in	7 Kg 15.4 £	
Y2/250/R	Y2/250/R/AN	Y2/250/R/BL	120x250 cm 47.2x96.7 in	173 cm 68.1 in	7,5 Kg 16.5 £	

53 cm
20.9 in



Classic Pinboard

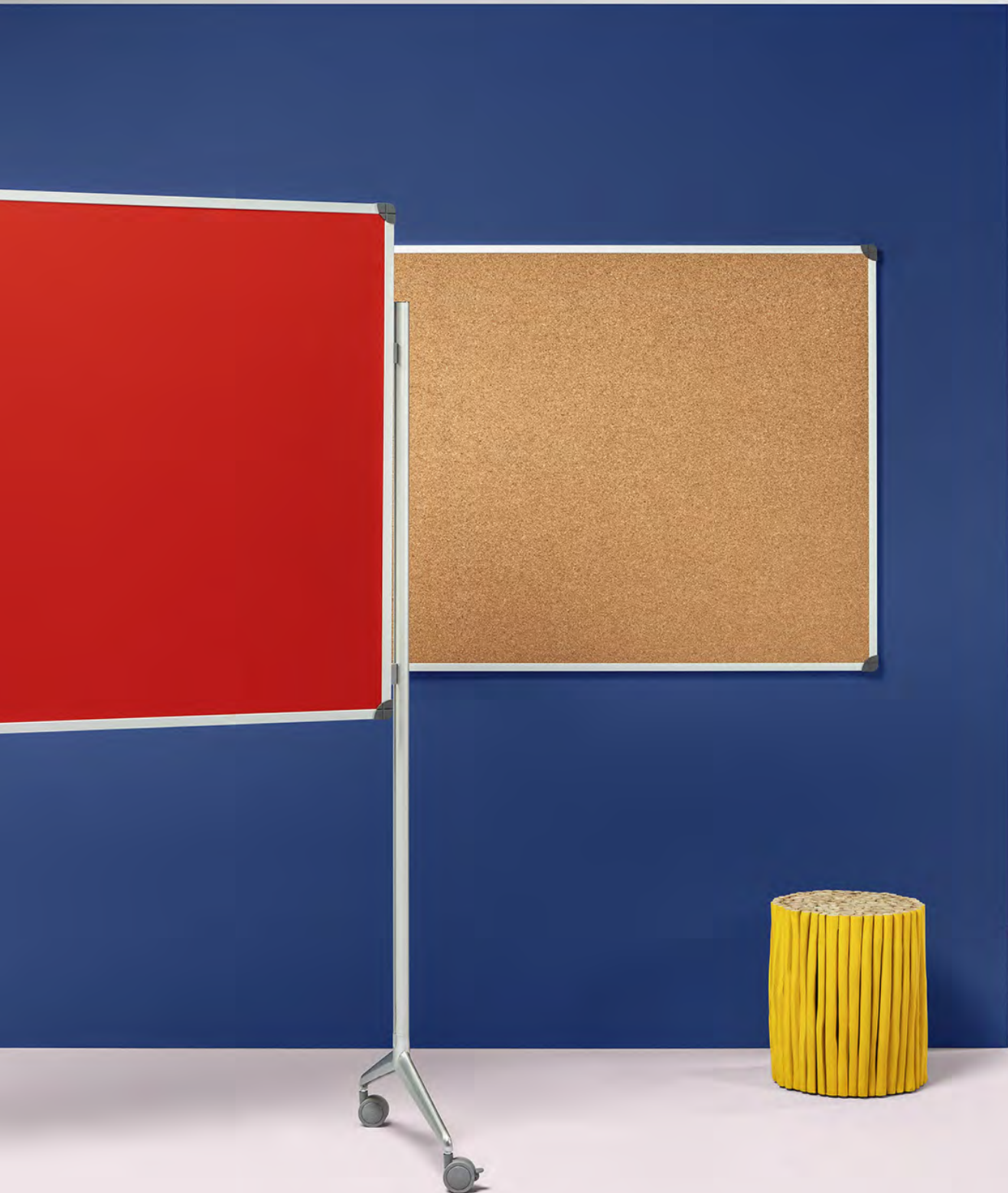

Upholstered notice board or natural visible cork, framed with a matt silver anodized classic aluminum profile and gray plastic corner pieces to avoid bumps. Available to fix both on the wall or mobile supports with castors and brakes. Notes, notices can be attached to its surface using pins or thumbtacks. 5 mm thick cork. Choice of textile range in 12 colors.

Tablero de anuncios tapizado o corcho visto natural, enmarcado con perfil de aluminio Classic anodizado plata mate y cantoneras de plástico gris en las esquinas para evitar golpes. Disponibles para fijarse tanto en la pared, como sobre soportes móviles con ruedas y freno. Sobre su superficie se pueden fijar notas, avisos, comunicados, etc... mediante agujas o chinchetas. Corcho de 5 mm de grosor. Gama a elegir de textil en 12 colores.

Tableau d'affichage tapissé ou en liège naturel, encadré d'un profil en aluminium Classic anodisé avec angles en plastique gris pour éviter les coups. Disponible pour le fixer aussi bien au mur que sur des supports mobiles avec roues et frein. Les notes, avis, communiqués etc. peuvent être fixés sur la surface à l'aide d'aiguilles ou de punaises. Liège de 5 mm d'épaisseur. Tissu à choisir parmi 12 coloris.

Sizes

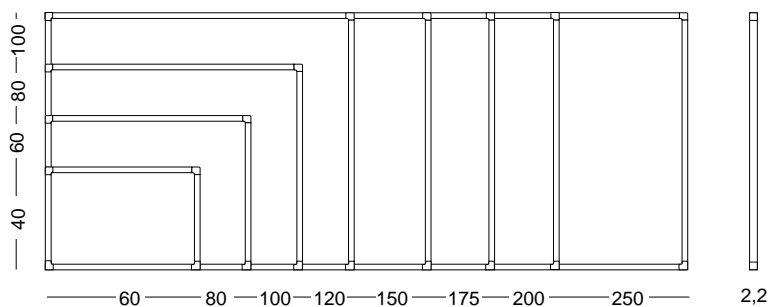

Specs



Cork



Textiles colours



/NG

/GR

/CR

/OC

/NJ

/RJ

/BD

/AC

/AZ

/VM

/VC

/VD



Classic Pinboard

Aluminium frames

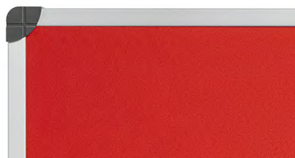
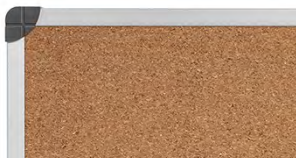

WALL  CORK → ←

REF	↕ ↔		RAIL	T	Y2	
765/10	40x60 cm 15.7x23.6 in	2,4 Kg 5.2 £				2,2 cm 0.9 in
765/1	60x80 cm 23.6x31.5 in	4.8 Kg 10.5 £				
765/2	80x100 cm 31.5x39.3 in	8 Kg 17.6 £	.	.	.	
765/3	100x120 cm 39.3x47.2 in	12 Kg 26.4 £	.	.	.	
765/4	100x150 cm 39.3x60 in	15 Kg 33 £	.	.	.	
765/5	100x175 cm 39.3x70 in	17.5 Kg 38.5 £	.	.	.	
765/6	100x200 cm 39.3x78.7 in	24Kg 52.9 £	.	.	.	
765/7	100x250 cm 39.3x98.4 in	32Kg 70.5 £	.	.	.	

WALL  TEXTILES → ←

REF	TEXTIL COLOUR	↕ ↔		RAIL	T	Y2	
760/10	● /NG ● /BD	40x60 cm 15.7x23.6 in	2,4 Kg 5.2 £				2,2 cm 0.9 in
760/1	● /GR ● /AC	60x80 cm 23.6x31.5 in	4.8 Kg 10.5 £				
760/2	● /CR ● /AZ	80x100 cm 31.5x39.3 in	8 Kg 17.6 £	.	.	.	
760/3	● /OC ● /VM	100x120 cm 39.3x47.2 in	12 Kg 26.4 £	.	.	.	
760/4	● /NJ ● /VC	100x150 cm 39.3x60 in	15 Kg 33 £	.	.	.	
760/5	● /RJ ● /VD	100x175 cm 39.3x70 in	17.5 Kg 38.5 £	.	.	.	
760/6		100x200 cm 39.3x78.7 in	24Kg 52.9 £	.	.	.	
760/7		100x250 cm 39.3x98.4 in	32Kg 70.5 £	.	.	.	

Supports



SUPPORT

AVAILABLE SIZES

●	●	○	↕ ↔	↕	👤	↔
770/1	770/1/AN	770/1/BL	80x100 cm 31.5x39.3 in	174 cm 68.5 in	7 Kg 15.4 £	53 cm 68.5 in
			100x120 cm 39.3x47.2 in			
			100x150 cm 39.3x60 in			
			100x175 cm 39.3x70 in			
			120x200 cm 47.2x78.7 in			

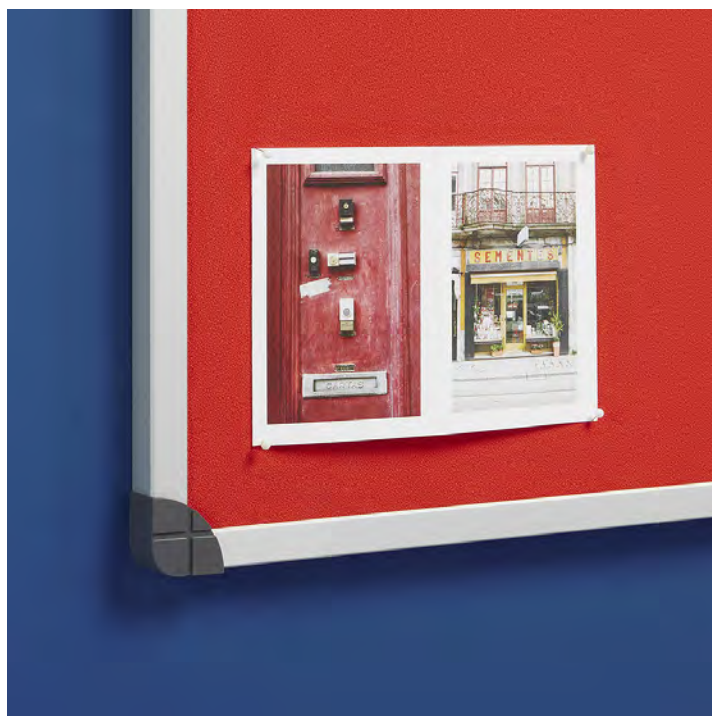

SUPPORT

AVAILABLE SIZES



●	●	○	↕ ↔	↕	👤	↔
Y2/80/R	Y2/80/R/AN	Y2/80/R/BL	80x100 cm 31.5x39.3 in	173 cm 68.1 in	5 Kg 11 £	53 cm 68.5 in
Y2/120/R	Y2/120/R/AN	Y2/120/R/BL	100x120 cm 39.3x47.2 in		6 Kg 13.2 £	
Y2/150/R	Y2/150/R/AN	Y2/150/R/BL	100x150 cm 39.3x60 in		6,5 Kg 14.3 £	
Y2/200/R	Y2/200/R/AN	Y2/200/R/BL	120x200 cm 47.2x78.7 in		7 Kg 15.4 £	
Y2/250/R	Y2/250/R/AN	Y2/250/R/BL	120x250 cm 47.2x96.7 in		7,5 Kg 16.5 £	

MORE DETAILS ABOUT THE SUPPORTS

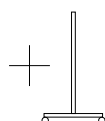

→ VIEW ON PAGE: 92

R · PET Pinboard



Upholstered wall notice board or natural visible cork, made with extruded profile and injected corner pieces of R-Pet Classic recycled plastic in gray. The PET we use in the boards comes from 100% recycled bottles and containers in order to improve the sustainability of the planet by investing in new long-life products. Notes, notices can be attached to its surface using pins or thumbtacks. 5 mm thick cork. Choice of textile range in 12 colors.

Tablero de anuncios mural tapizado o corcho visto natural, fabricado con perfil extrusionado y cantoneras inyectadas de plástico reciclado R-Pet Classic de color gris. El PET que usamos en los tableros proviene de botellas y envases 100% reciclados con el fin de mejorar la sostenibilidad del planeta invirtiendo en unos nuevos productos de larga vida útil. Sobre su superficie se pueden fijar notas, avisos, comunicados etc... mediante agujas o chinchetas. Corcho de 5 mm de grosor. Gama a elegir de textil en 12 colores.

Tableau d'affichage mural tapissé ou en liège naturel, fabriqué avec un profil extrudé et des coins injectés en plastique recyclé R-Pet Classic gris. Le PET que nous utilisons pour nos tableaux provient de bouteilles et de conteneurs en plastique 100% recyclés, en investissant dans de nouveaux produits longue durée, nous contribuons à améliorer la durabilité de notre planète. Les notes, avis, communiqués etc. peuvent être fixés sur la surface à l'aide d'aiguilles ou de punaises. Liège de 5 mm d'épaisseur. Tissu à choisir parmi 12 coloris.

Sizes

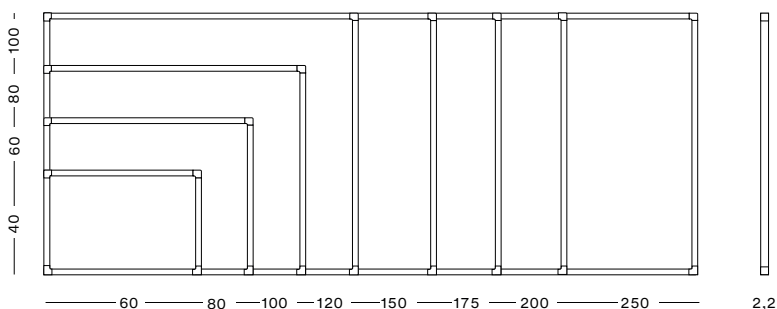

Specs



Cork



Textiles colours





R · PET Pinboard

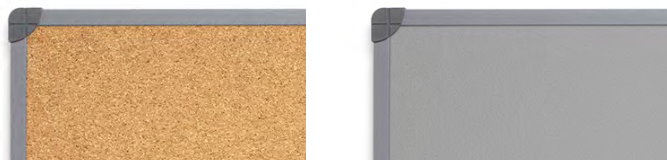





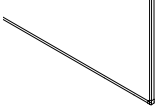





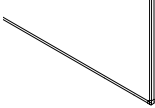

Aluminium frames



WALL CORK → ←

				RAIL	T	Y2	
	765/10/REC	40x60 cm 15.7x23.6 in	2,4 Kg 5.2 £				2,2 cm 0.9 in
	765/1/REC	60x80 cm 23.6x31.5 in	4.8 Kg 10.5 £				
	765/2/REC	80x100 cm 31.5x39.3 in	8 Kg 17.6 £	.	.	.	
	765/3/REC	100x120 cm 39.3x47.2 in	12 Kg 26.4 £	.	.	.	
	765/4/REC	100x150 cm 39.3x60 in	15 Kg 33 £	.	.	.	
	765/5/REC	100x175 cm 39.3x70 in	17.5 Kg 38.5 £	.	.	.	
	765/6/REC	100x200 cm 39.3x78.7 in	24Kg 52.9 £	.	.	.	
	765/7/REC	100x250 cm 39.3x98.4 in	32Kg 70.5 £	.	.	.	

WALL TEXTILES → ←

	REF	TEXTIL COLOUR			RAIL	T	Y2	
	760/10/REC	 /NG  /BD	40x60 cm 15.7x23.6 in	2,4 Kg 5.2 £				2,2 cm 0.9 in
	760/1/REC	 /GR  /AC	60x80 cm 23.6x31.5 in	4.8 Kg 10.5 £				
	760/2/REC	 /CR  /AZ	80x100 cm 31.5x39.3 in	8 Kg 17.6 £	.	.	.	
	760/3/REC	 /OC  /VM	100x120 cm 39.3x47.2 in	12 Kg 26.4 £	.	.	.	
	760/4/REC	 /NJ  /VC	100x150 cm 39.3x60 in	15 Kg 33 £	.	.	.	
	760/5/REC	 /RJ  /VD	100x175 cm 39.3x70 in	17.5 Kg 38.5 £	.	.	.	
	760/6/REC		100x200 cm 39.3x78.7 in	24Kg 52.9 £	.	.	.	
	760/7/REC		100x250 cm 39.3x98.4 in	32Kg 70.5 £	.	.	.	

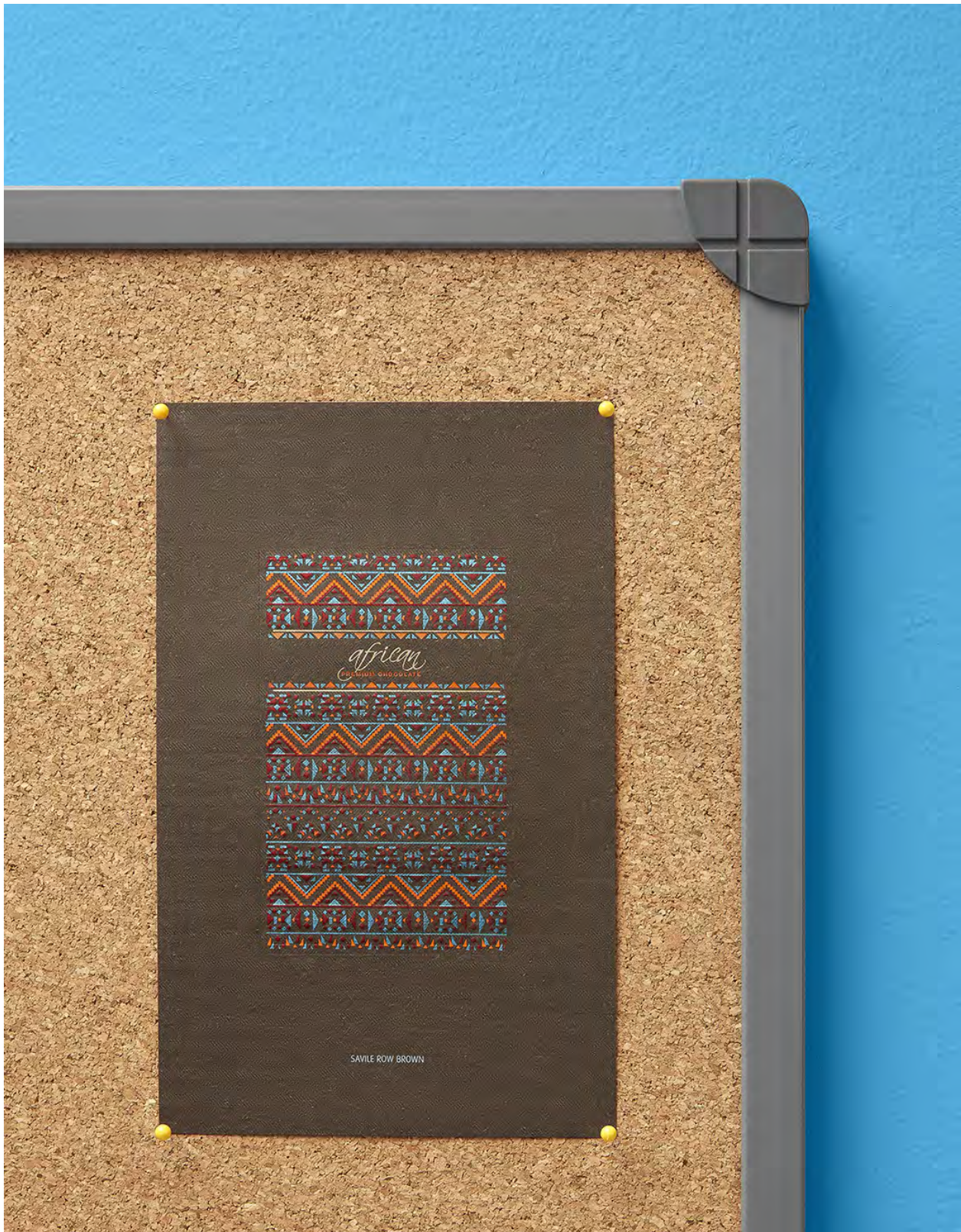

Zenit Pinboard



Zenit wall notice boards upholstered or natural visible cork, framed in aluminum profile with hidden anchors anodized matt silver. Available to fix both to the wall or on mobile supports with castors with brake mechanism. Notes, notices, etc ... Can be attached to its surface using pins or thumbtacks. 5 mm thick cork. Choice of 12 textile colours.

Tablero mural Zenit tapizado o corcho visto natural, enmarcado de perfil de aluminio con anclajes ocultos anodizado en color plata mate. Disponibles para fijarse tanto en la pared, como sobre soportes móviles con ruedas y freno. Sobre su superficie se pueden fijar notas, avisos, comunicados, etc... Mediante agujas o chinchetas. Corcho de 5 mm de grosor. Gama a elegir de textil en 12 colores.

Tableau mural Zenit tapissé ou en liège naturel, encadré d'un profilé en aluminium anodisé de couleur argent mat, fixation invisible. Disponible pour le fixer aussi bien sur le mur, que sur des supports mobiles avec roues et freins. Les notes, avis, circulaires etc. peuvent être attachés à sa surface à l'aide d'aiguilles ou de punaises. Liège de 5 mm d'épaisseur. Choix du tissu parmi 12 coloris.

Sizes

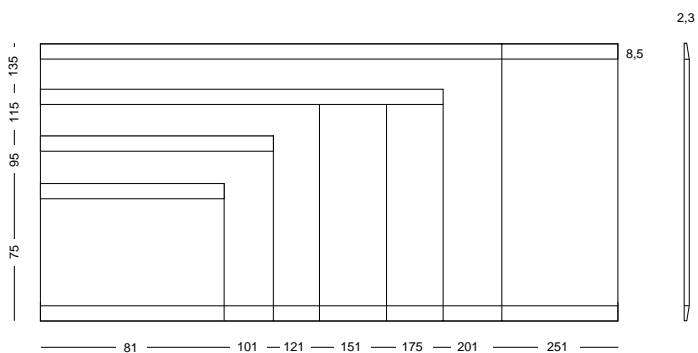

Specs



Cork



Textiles colours





Zenit Pinboard

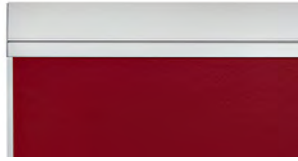





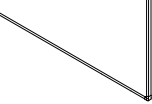





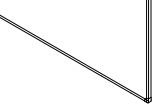

Aluminium frames



WALL CORK → ←

				RAIL	Y2	
	Z/765/10	40x60 cm 15.7x23.6 in	2,56 Kg 5.6 in			2,3 cm 0.9 in
	Z/765/1	60x80 cm 23.6x31.5 in	5,12 Kg 11.2 in			
	Z/765/2	80x100 cm 31.5x39.3 in	8,5 Kg 18.7 in	.	.	
	Z/765/3	100x120 cm 39.3x47.2 in	12,8 Kg 28.21 in	.	.	
	Z/765/4	100x150 cm 39.3x60 in	16 Kg 35.2 in	.	.	
	Z/765/5	100x175 cm 39.3x70 in	18,6 Kg 41 in	.		
	Z/765/6	100x200 cm 39.3x78.7 in	25,6 Kg 56.4 in		.	
	Z/765/7	100x250 cm 39.3x98.4 in	32 Kg 70.5 in		.	

WALL TEXTILES → ←

	REF	TEXTIL COLOUR			RAIL	Y2	
	Z/760/10	 /NG  /BD	40x60 cm 15.7x23.6 in	2,56 Kg 5.6 in			2,3 cm 0.9 in
	Z/760/1	 /GR  /AC	60x80 cm 23.6x31.5 in	5,12 Kg 11.2 in			
	Z/760/2	 /CR  /AZ	80x100 cm 31.5x39.3 in	8,5 Kg 18.7 in	.	.	
	Z/760/3	 /OC  /VM	100x120 cm 39.3x47.2 in	12,8 Kg 28.21 in	.	.	
	Z/760/4	 /NJ  /VC	100x150 cm 39.3x60 in	16 Kg 35.2 in	.	.	
	Z/760/5	 /RJ  /VD	100x175 cm 39.3x70 in	18,6 Kg 41 in	.		
	Z/760/6		100x200 cm 39.3x78.7 in	25,6 Kg 56.4 in		.	
	Z/760/7		100x250 cm 39.3x98.4 in	32 Kg 70.5 in		.	

Supports



AVAILABLE COLOURS

- /GR
- /AN
- /BL



SUPPORT			AVAILABLE SIZES	→ ←	
●	●	○	↕ ↔	↕	53 cm
Y2/80/R	Y2/80/R/AN	Y2/80/R/BL	80x100 cm 31.5x39.3 in	173 cm 68.1 in	20.9 in
Y2/120/R	Y2/120/R/AN	Y2/120/R/BL	100x120 cm 39.3x47.2 in		
Y2/150/R	Y2/150/R/AN	Y2/150/R/BL	100x150 cm 39.3x60 in		
Y2/200/R	Y2/200/R/AN	Y2/200/R/BL	120x200 cm 47.2x78.7 in		
Y2/250/R	Y2/250/R/AN	Y2/250/R/BL	120x250 cm 47.2x96.7 in		



MORE DETAILS ABOUT THE SUPPORT



→ VIEW ON PAGE: 92

Basic Pinboard



Notice board in natural cork framed with a basic extruded aluminum profile anodized in matt silver and equipped with rounded gray plastic corner pieces. Notes, notices can be attached to its surface using pins or thumbtacks.

Tablero de anuncios de corcho natural enmarcado con perfil de aluminio extrusionado Basic anodizado en plata mate y dotado de cantoneras redondeadas de plástico gris. Sobre su superficie se pueden fijar notas, avisos, comunicados etc... mediante agujas o chinchetas.

Tableau d'affichage en liège naturel encadré d'un profilé en aluminium extrudé Basic anodisé en argent mat et équipé de coins arrondis en plastique gris. Les notes, avis, communiqués etc... peuvent être fixés sur la surface à l'aide d'aiguilles ou de punaises.

Sizes

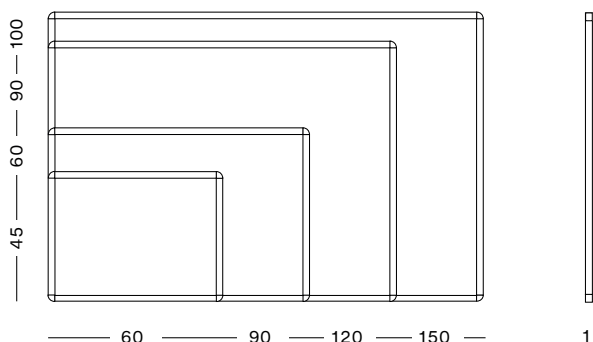

Specs



Cork



Aluminium frame



WALL

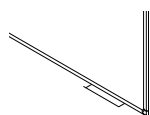

REF	Size (cm)	Size (in)	Weight (Kg)	Weight (£)	Thickness (cm)
BL/IN/0101	45x60 cm	17.7x23.6 in	2 Kg	4.4 £	0.4 in
BL/IN/0102	60x90 cm	23.6x35.4 in	4 Kg	8.82 £	
BL/IN/0103	90x120 cm	35.4x47.2 in	8 Kg	17.64 £	
BL/IN/0114	100x150 cm	39.3x59 in	11 Kg	24.25 £	

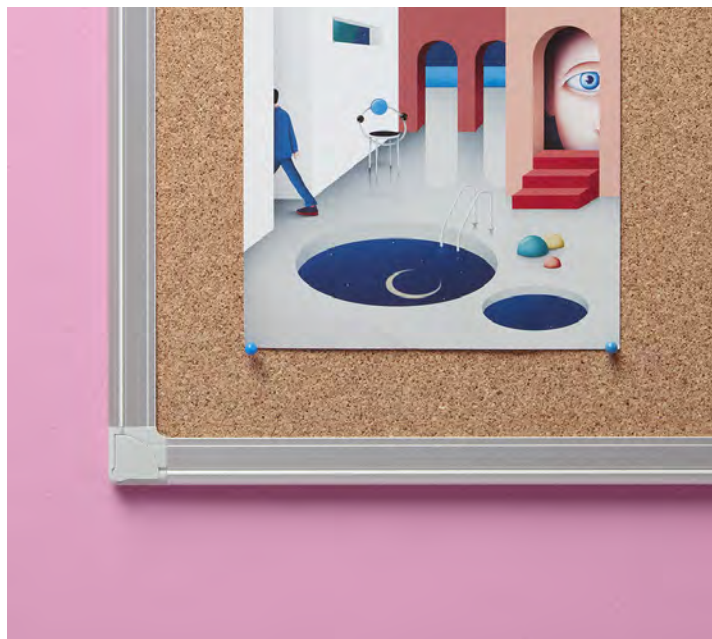

Chameleon Pinboard



Chameleon family notice boards made from 6 mm linoleum sheets on a rigid wooden frame with a total thickness of 16 mm. Its surface allows you to fix notes and notices with thumbtacks or pins and has acoustic properties that help prevent reverberation in the spaces where they are located. Available in 15 colors. Beveled edges. Sound absorption coefficient α_w 0,1 (typical).

Tablero de anuncios de la familia Chameleon fabricados con planchas de linoleum de 6 mm sobre bastidor rígido de madera con un grosor total de 16 mm. Su superficie permite fijar notas y avisos con agujas o chinchetas y tiene propiedades acústicas que ayudan a evitar la reverberación en los espacios donde se ubican. Disponibles en 15 colores. Cantos biselados. Coeficiente de absorción: α_w 0,1 (typical).

Tableau d'affichage de la famille Chameleon fabriqué avec un linoléum de 6 mm sur un cadre en bois rigide d'une épaisseur totale de 16 mm. Sa surface permet de fixer des notes et des avis avec des aiguilles ou des punaises et possède des propriétés acoustiques qui aident à éviter la réverbération dans les espaces où ils se trouvent. Disponible en 15 couleurs. Bords biseautés. Coefficient d'absorption acoustique: α_w 0,1 (typical).

Sizes

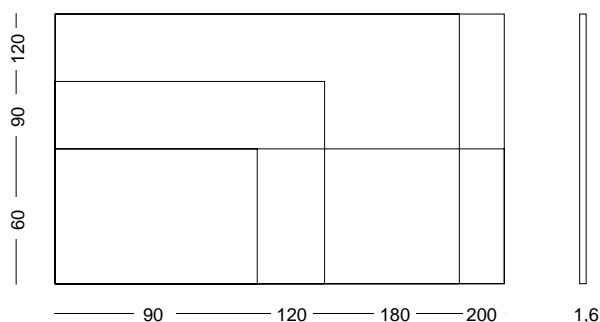

Specs



Colours



No frame



WALL



REF	↕ ↔	📏	1,6 cm
7600/1	60x90 cm 23.6x35 in	8,00 Kg 17.6 £	0.6 in
7600/2	90x120 cm 35.0x47.2 in	14,00 Kg 30.8 £	
7600/3	120x180 cm 47.2x70.8 in	28,40 Kg 62.6 £	
7600/4	120x200 cm 47.2x78.7 in	32,60 Kg 71.8 £	
7600/5	200x60 cm 78.7x23.6 in	16,30 Kg 35.9 £	



Chameleon Geometric Pinboard



Hexagonal and circular notice boards from the Chameleon family made with 6 mm linoleum sheets on a rigid wooden frame with a total thickness of 16 mm. Its surface allows to fix notes and notices with thumbtacks or pins and has acoustic properties that help prevent reverberation in the spaces where they are located. Available in 15 colors. Diameter 60 cm. Beveled edges.

Tablero hexagonal y circular de anuncios de la familia Chameleon fabricados con planchas de linoleum de 6 mm sobre bastidor rígido de madera con un grosor total de 16 mm. Su superficie permite fijar notas y avisos con agujas o chinchetas y tiene propiedades acústicas que ayudan a evitar la reverberación en los espacios donde se ubican. Disponibles en 15 colores. Diámetro 60 cm. Cantos biselados.

Tableau d'affichage hexagonal et circulaire de la famille Chameleon fabriqué avec un linoléum de 6 mm sur un cadre en bois rigide d'une épaisseur totale de 16 mm. Sa surface permet de fixer des notes et des avis avec des aiguilles ou des punaises et possède des propriétés acoustiques qui aident à éviter la réverbération dans les espaces où ils se trouvent. Disponible en 15 couleurs. Diamètre 60 cm. Bords biseautés.

Sizes

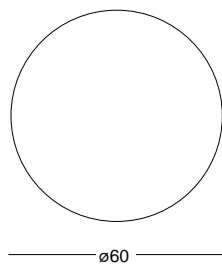
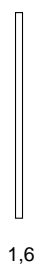
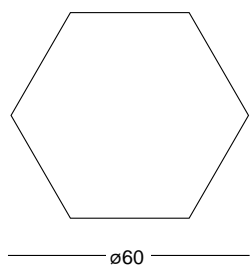

Specs



Colours



No frame

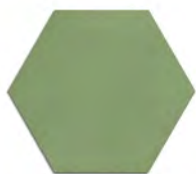

WALL

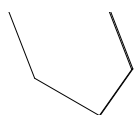

REF
7606/1

∅
60 cm
1.6 in

⚖
23,6 Kg
0.6 £ 1,6 cm
0.6 in

WALL

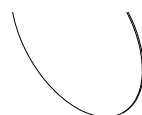

REF
7608/1

∅
60 cm
1.6 in

⚖
23,6 Kg
0.6 £ 1,6 cm
0.6 in

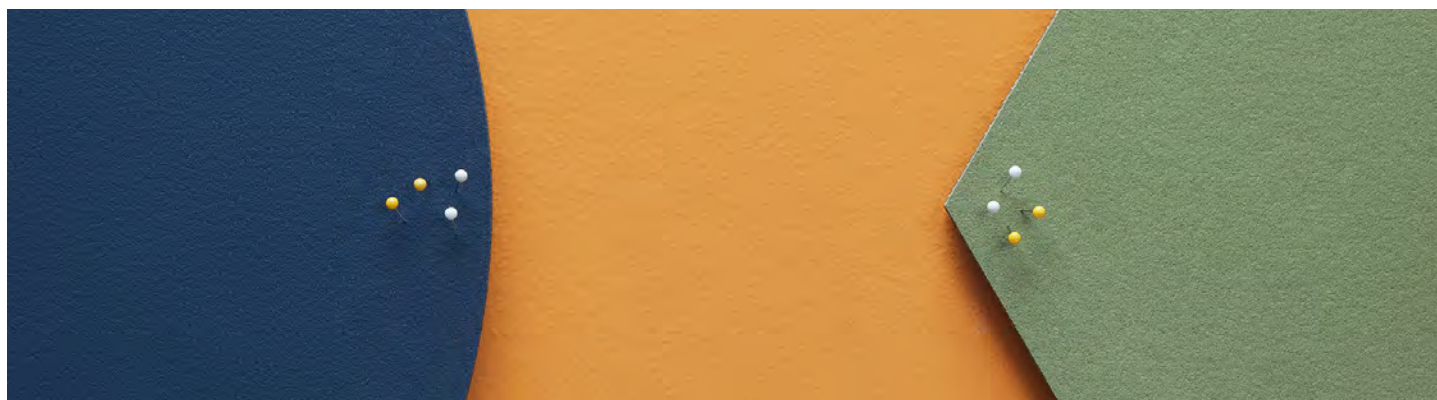

Pinboards Showcase

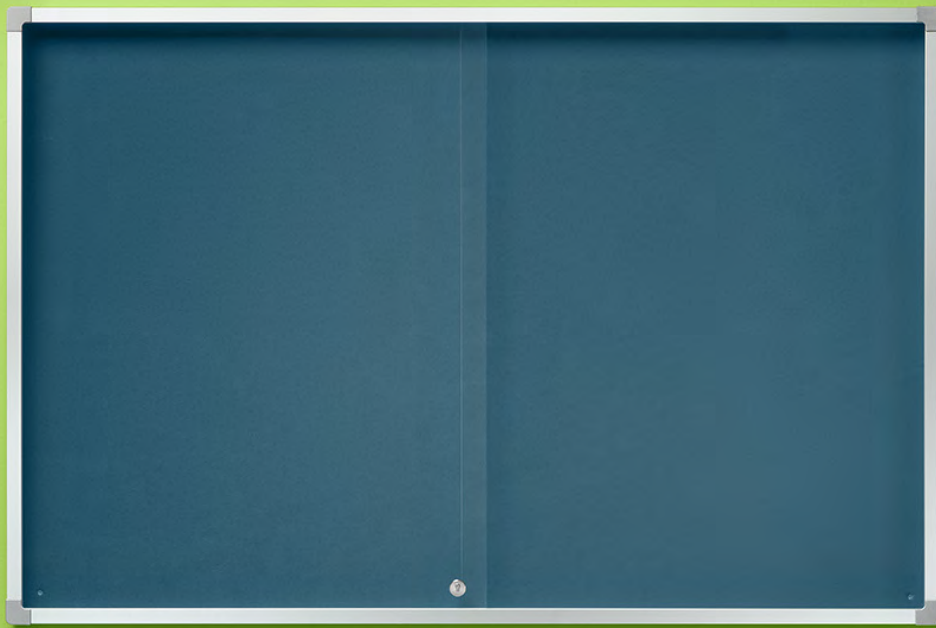

Wall display cabinet made of matt silver anodized aluminum profile and equipped with gray zamak corner pieces. Background made of natural cork or upholstered cork available in 12-color textile. Transparent methacrylate sliding doors and security lock with set of keys. Cork thickness 5 mm. Showcases for indoor use.

Vitrina de anuncios mural fabricada con perfil de aluminio anodizado plata mate y dotada de cantoneras de zamak color gris. Fondo de corcho natural o corcho tapizado disponible en textil de 12 colores. Puertas correderas deslizantes de metacrilato transparente y cerradura de seguridad con juego de llaves. Grosor del corcho 5 mm. Vitrinas para uso interior.

Vitrine murale fabriquée en profilé d'aluminium anodisé argent mat et équipée d'angles en zamak gris. Fond en liège naturel ou en liège tapissé, 12 couleurs à choisir parmi notre gamme de tissus. Portes coulissantes transparentes en méthacrylate et serrure de sécurité avec jeu de clés. Epaisseur du liège 5 mm. Vitrine pour un usage intérieur.

Sizes

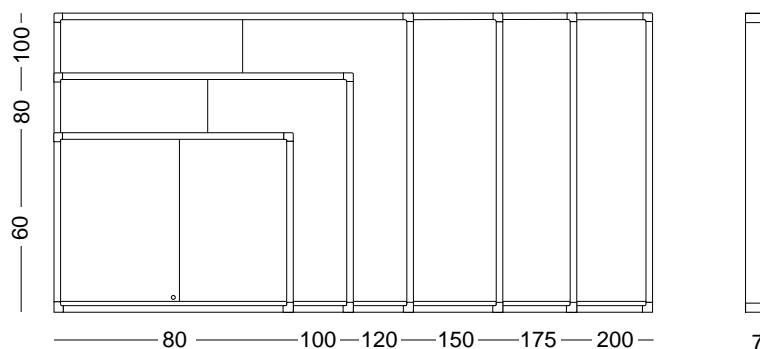

Specs



Cork



Textiles colours

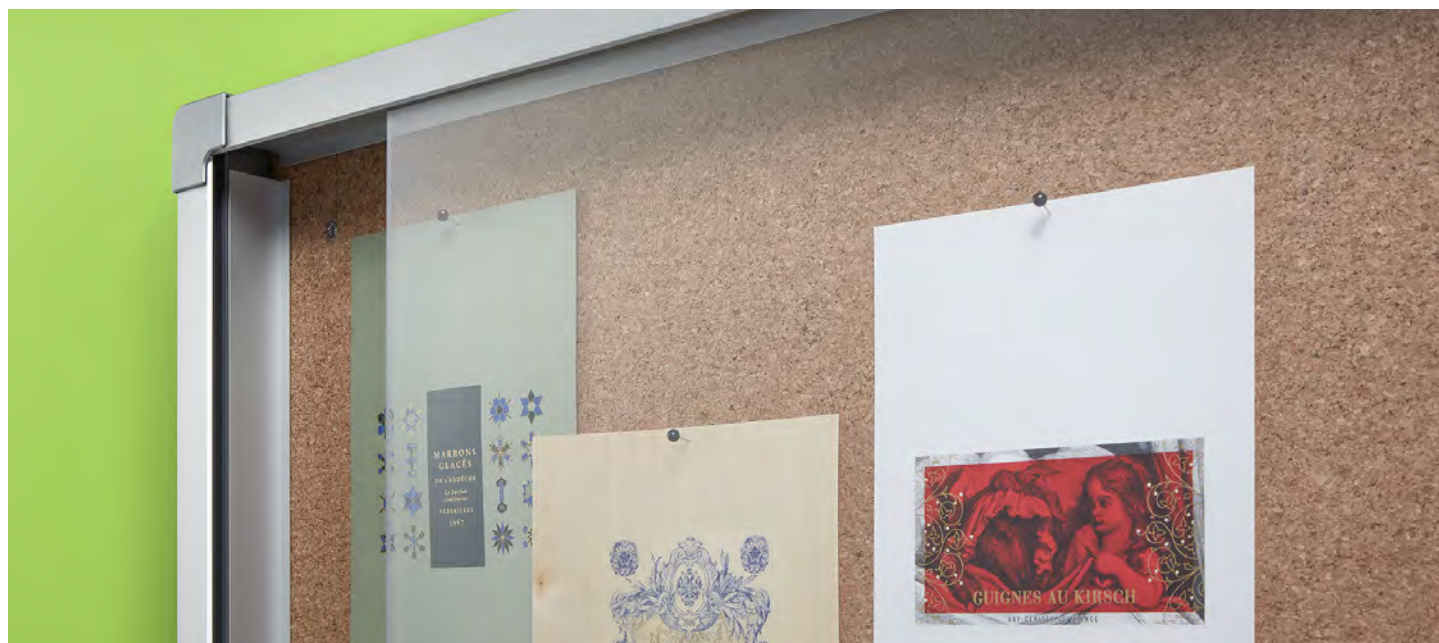
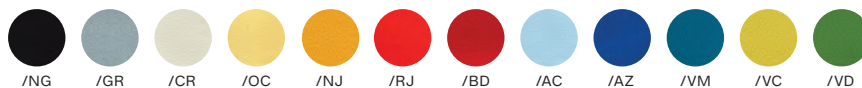

Pinboards Showcase

Aluminium frames

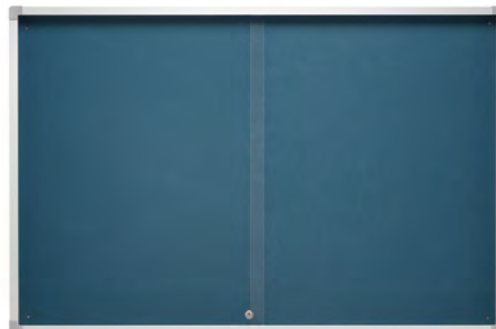

WALL

 CORK

→ ←

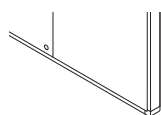

REF	↕ ↔	🏋️
765/V1	60x80 cm 23.6x31.5 in	10 Kg 22 £
765/V2	80x100 cm 31.5x39.3 in	17 Kg 37.4 £
765/V3	100x120 cm 39.3x47.2 in	23 Kg 50.7 £
765/V4	100x150 cm 39.3x60 in	30 Kg 66.1 £
765/V5	100x175 cm 39.3x70 in	32 Kg 70.5 £
765/V6	100x200 cm 39.3x78.7 in	35 Kg 77.1 £

7 cm
2.7 in

WALL

 TEXTILES

→ ←

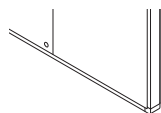

REF	TEXTIL COLOUR	↕ ↔	🏋️
760/V1	● /NG ● /BD	60x80 cm 23.6x31.5 in	10 Kg 22 £
760/V2	● /GR ● /AC	80x100 cm 31.5x39.3 in	17 Kg 37.4 £
760/V3	● /CR ● /AZ	100x120 cm 39.3x47.2 in	23 Kg 50.7 £
760/V4	● /OC ● /VM	100x150 cm 39.3x60 in	30 Kg 66.1 £
760/V5	● /NJ ● /VC	100x175 cm 39.3x70 in	32 Kg 70.5 £
760/V6	● /RJ ● /VD	100x200 cm 39.3x78.7 in	35 Kg 77.1 £

7 cm
2.7 in



Basic Showcase



Collection of Basic display cabinets made with a matt silver anodized aluminum profile and equipped with gray rounded corner pieces. Transparent methacrylate hinged opening door with lock and key. Available in white magnetic labeling finish for magnets and in natural cork to hold notices and notes using thumbtacks or push pins. Vitrinas for indoor use.

Colección de vitrinas Basic fabricadas con perfil de aluminio anodizado plata mate y dotadas de cantoneras redondeadas grises en las esquinas. Puerta de apertura batiente de metacrilato transparente con cerradura y llave. Disponibles en acabado blanca rotulable magnética para imanes y en corcho natural para sujetar avisos y notas mediante agujas o chinchetas. Vitrinas para uso interior.

Collection de vitrines Basic réalisées avec un profil en aluminium anodisé argent mat et équipées de coins arrondis gris. Porte battante à charnière en méthacrylate transparent avec serrure et clé. Fond disponible dans une finition magnétique blanche effaçable à sec ou en liège naturel pour fixer vos informations à l'aide d'aiguilles ou de punaises. Vitrine pour un usage intérieur.

Sizes

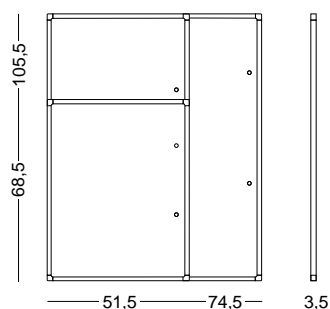

Options + Specs

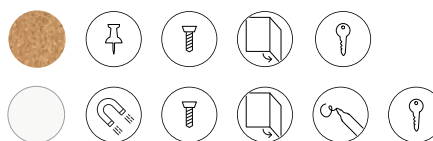

Aluminium frame

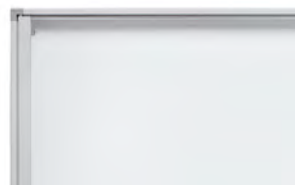

WALL		PINBOARD				WHITEBOARD				↔
REF	↕ ↔	📏	📄	REF	↕ ↔	📏	📄			
BL/IN/0150	68,5x51,5 cm 26.9x20.2 in	4,5 Kg 9.9 £	6	BL/IN/0110	68,5x51,5 cm 26.9x20.2 in	4,5 Kg 9.9 £	6		3,5 cm 1.3 in	
BL/IN/0151	100,5x51,5 cm 39.5x20.2 in	6,5 Kg 14.3 £	8	BL/IN/0111	100,5x51,5 cm 39.5x20.2 in	6,5 Kg 14.3 £	8			
BL/IN/0152	100,5x74,5 cm 39.5x29.3 in	8,7 Kg 19.1 £	10	BL/IN/0112	100,5x74,5 cm 39.5x29.3 in	8,7 Kg 19.1 £	10			

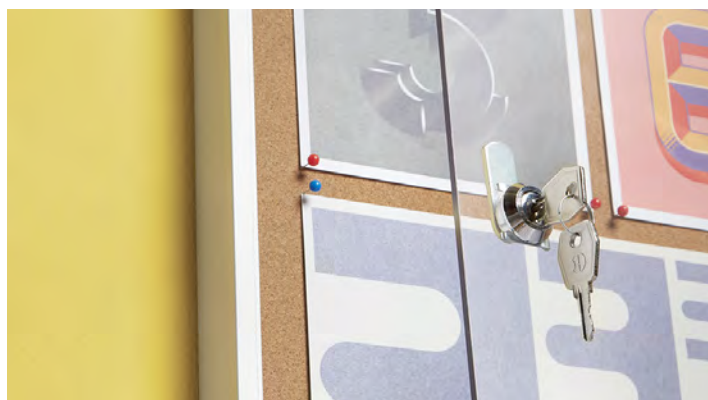

Outdoor Showcase



Outdoor display cabinets made of matt silver anodized aluminum profiles and rounded gray plastic corner pieces with optional colour detail. (6 color kit included). Hinged tempered glass door with key lock. Magnetic labeling surface for use with magnets. Waterproof allowing outdoor use.

Vitrinas para exterior fabricadas con perfiles de aluminio anodizados plata mate y cantoneras redondeadas de plástico gris con detalle opcional de color (kit de 6 colores incluido). Puerta batiente de cristal templado dotada de cerradura con llave. Superficie rotulable magnética para uso con imanes. Estancas a la lluvia por lo que permiten su ubicación a la intemperie.

Vitrines extérieures en profilés d'aluminium anodisé argent mat et coins arrondis en plastique gris avec détail de couleur en option. (Kit 6 couleurs inclus). Porte en verre trempé à ouverture télescopique équipée d'une double serrure à clé. Surface magnétique à utiliser avec des aimants. Imperméable et résistante à la pluie ce qui vous permet de l'installer à l'extérieur.

Sizes

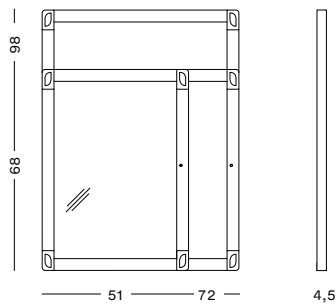

Specs

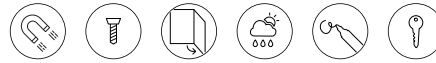

Aluminium frame

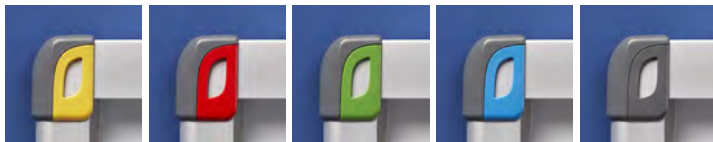
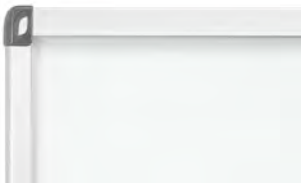

WALL	WHITEBOARD		→ K		
REF	↕ ↔	⊠ ⊠	⚖	A4	4,5 cm
767/VE/12	68x51 cm 26.5x20 in	59,4x41,8 cm 23.3x16.4 in	4,5 Kg 9.9 £	4	1.8 in
767/VE/13	68x72 cm 26.5x28.3 in	59,4x62,8cm 23.3x24.7 in	6,5 Kg 14.3 £	6	
767/VE/14	98x72 cm 38.6x28.3 in	89,1x62,8 cm 35x24.7 in	8,7 Kg 19.1 £	9	

*
Included color pieces
Piezas de colores incluidas
Pièces de couleur incluses



Outdoor Telescopic Showcase



Outdoor display cabinets made of matt silver anodized aluminum profiles and rounded gray plastic corner pieces with optional color detail. (6 color kit included). Tempered glass door with telescopic opening equipped with a double key lock. Magnetic labeling surface for use with magnets. Waterproof allowing outdoor use.

Vitrinas para exterior fabricadas con perfiles de aluminio anodizados plata mate y cantoneras redondeadas de plástico gris con detalle opcional de plástico gris con detalle opcional de color (kit de 6 colores incluido). Puerta con apertura telescópica de cristal templado dotada de doble cerradura con llave. Superficie rotulable magnética para uso con imanes. Estancas a la lluvia por lo que permiten su ubicación a la intemperie.

Vitrines extérieures en profilés d'aluminium anodisé argent mat et coins arrondis en plastique gris avec détail de couleur en option. (Kit 6 couleurs inclus). Porte en verre trempé à ouverture télescopique équipée d'une double serrure à clé. Surface magnétique à utiliser avec des aimants. Imperméable et résistante à la pluie ce qui vous permet de l'installer à l'extérieur.

Sizes

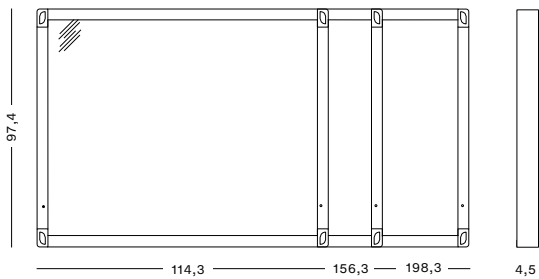

Specs

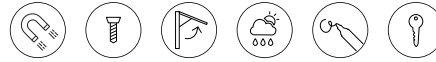

Aluminium frame

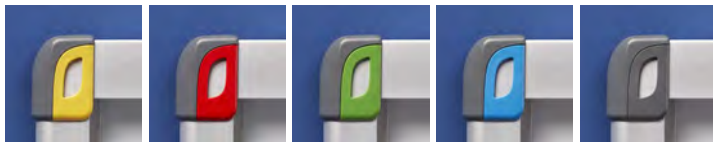
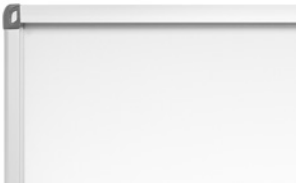

WALL

WHITEBOARD



REF	↕ ↔	⊠ ⊞	⚖	📄	4,5 cm
768/VE/11	97,4x114,3 cm 39x47.6 in	89,2x105 cm 35.1x41.3 in	4,5 Kg 9.9 £	15	1.7 in
768/VE/12	97,4x156,3 cm 39x64.2 in	89,2x147cm 35.1x57.8 in	6,5 Kg 14.3 £	21	
768/VE/13	97,4x198,3 cm 39.7x80.3 in	89,2x189 cm 35.1x74.4 in	8,7 Kg 19.1 £	27	

*
Included color pieces
Piezas de colores incluidas
Pièces de couleur incluses



Acoustic

PFA Acoustic Panel	140
Screen Acoustic Panel	144
Limit Acoustic Screen	148
Ten Limit Acoustic Screen	152
Foam Acoustic	156
R·PET Acoustic	162
Accessories	167

Silence is a precious asset in offices, restaurants, and both public and private places. We are aware that sound is necessary, but to minimize its impact in these chaotic environments, it is a necessity at Planning Sisplamo we have decided to work to achieve a better environment that maintains harmony and reduces reverberation and therefore better well-being among users. Calm generates happiness in the workplace and relaxation in those gastronomic places that we appreciate enjoy and share so much.

El silencio es un bienpreciado en las oficinas, restaurantes y espacios tanto públicos como privados. Somos conscientes que el sonido es necesario, pero minimizar su impacto en estos entornos caóticos, es una necesidad que desde Planning Sisplamo hemos decidido trabajar para conseguir un mejor ambiente que mantenga una armonía y reduzca la reverberación y por consiguiente un mejor bienestar entre los usuarios. La calma genera felicidad en los puestos de trabajo y relajación en esos espacios gastronómicos que tanto apreciamos y compartimos.

Le silence est un atout précieux dans les bureaux, les restaurants et les espaces publics ou privés. Nous sommes conscients que le son est nécessaire, mais pour minimiser son impact dans ces environnements chaotiques, Planning Sisplamo a décidé de travailler pour obtenir un meilleur environnement qui maintient l'harmonie et réduit la réverbération et donc un meilleur bien-être parmi les utilisateurs. . Le calme génère le bonheur au bureau et la détente dans ces espaces gastronomiques que nous apprécions et partageons tant.



PFA Acoustic Panel

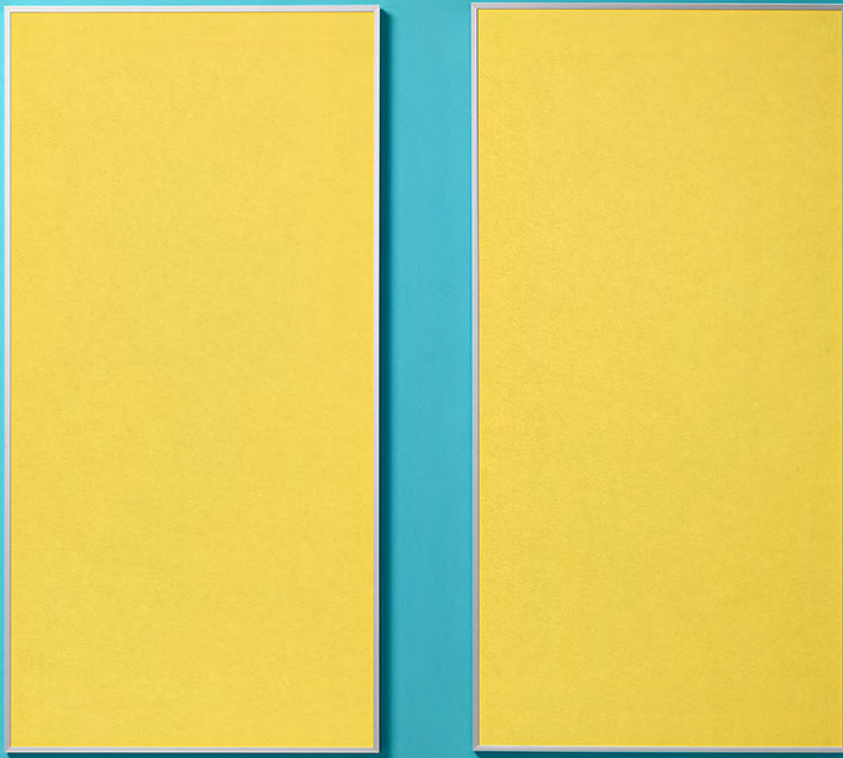

Sound absorbing panel framed with anodized Slim aluminum profile in matt silver colour. Made with a high percentage of recycled material: 60% recycled polyester fibers from PET plastic bottles and 40% from new polyester fibers. Acoustic properties: alpha m: 0.25. NRC: 0.30. 0.9mm PET thickness. Available in 7 colors. It allows you to place notes and reminders using thumb tacks or pins.

Panel fonoabsorbente enmarcado con perfil de aluminio Slim anodizado en color plata mate. Fabricado con alto porcentaje de material reciclado: 60% fibras de poliéster reciclado de botellas de plástico PET y 40% de nuevas fibras de poliéster. Propiedades acústicas: alpha m: 0,25. NRC: 0,30. Grosor de PET 0,9 mm. Disponible en 7 colores. Permite colocar notas y avisos mediante agujas o chinchetas.

Panneau acoustique phono-absorbant encadré d'un fin profil en aluminium anodisé de couleur argent mat. Fabriqué avec un pourcentage élevé de matériaux recyclés: 60% de fibres de polyester recyclées à partir de bouteilles en plastique PET et 40% de nouvelles fibres de polyester. Propriétés acoustiques: alpha m: 0,25. NRC: 0,30. Epaisseur du PET 0,9 mm. Disponible en 7 couleurs. Il permet de placer des notes et des avis à l'aide de punaises ou d'épingles.

Sizes

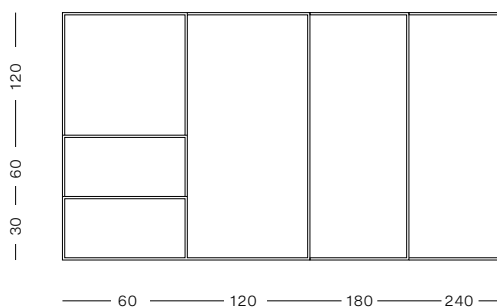

Specs



Colours



PFA Acoustic Panel

Aluminium frames

No frame

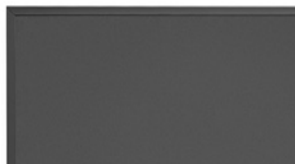
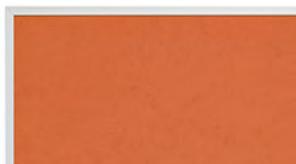

WALL	WITH FRAME			PFA COLOUR	↕ ↔	🏠	ALPHA M	→ ←
	●	●	○	● /NG	30x60 cm 11.8x23.6 in	0,8 Kg 1.7 £	0,25	2,3 cm 0.9 in
	PFA/1/PL	PFA/1/AN	PFA/1/BL	● /GR	60x60 cm 23.6x23.6 in	1,4 Kg 3 £	0,25	
	PFA/2/PL	PFA/2/AN	PFA/2/BL	● /AN	60x120 cm 23.6x47.2 in	2,4 Kg 5.2 £	0,25	
	PFA/3/PL	PFA/3/AN	PFA/3/BL	● /NJ	120x120 cm 47.2x47.2 in	4,2 Kg 9.2 £	0,25	
	PFA/4/PL	PFA/4/AN	PFA/4/BL	● /AM	120x180 cm 47.2x70.8 in	6,7 Kg 14.2 £	0,25	
	PFA/5/PL	PFA/5/AN	PFA/5/BL	● /AZ	120x240 cm 47.8x94.4 in	8,5 Kg 18.7 £	0,25	
PFA/6/PL	PFA/6/AN	PFA/6/BL	● /VD					

WALL	NO FRAME			PFA COLOUR	↕ ↔	🏠	ALPHA M	→ ←
	REF							0,9 cm 0.3 in
	PFA/1	● /NG			30x60 cm 11.8x23.6 in	0,2 Kg 0.4 £	0,25	
	PFA/2	● /GR			60x60 cm 23.6x23.6 in	0,3 Kg 0.7 £	0,25	
	PFA/3	● /AN			60x120 cm 23.6x47.2 in	0,7 Kg 1.7 £	0,25	
	PFA/4	● /NJ			120x120 cm 47.2x47.2 in	1,3 Kg 3 £	0,25	
	PFA/5	● /AM			120x180 cm 47.2x70.8 in	1,9 Kg 4.2 £	0,25	
PFA/6	● /AZ			120x240 cm 47.8x94.4 in	2,7 Kg 6 £	0,25		

ACCESSORIES



ACC/PFA/03
Suspension kit 2m
Kit de suspensión de 2m
Kit de suspension 2m



ACC/PFA/04
Adhesive wall / Roof
Adhesivo de pared / Techo
Adhésif mur / Toit

Support T



AVAILABLE COLORS

- /GR
- /AN
- /BL



SUPPORT

AVAILABLE SIZES



				↕ ↔	↕	7 Kg 15.4 £	53 cm 20.9 in
770/1	770/1/AN	770/1/BL		60x120 cm 39.3x47.2 in	174 cm 68,5 in		
770/1	770/1/AN	770/1/BL		120x120 cm 47.2x47.2 in			
770/1	770/1/AN	770/1/BL		120x180 cm 47.2x70.8 in			

Support Y2



AVAILABLE COLORS

- /GR
- /AN
- /BL



SUPPORT

AVAILABLE SIZES



				↕ ↔	↕	53 cm 20.9 in
Y2/80/R	Y2/80/R/AN	Y2/80/R/BL		80x100 cm 31.5x39.3 in	173 cm 68.1 in	
Y2/120/R	Y2/120/R/AN	Y2/120/R/BL		100x120 cm 39.3x47.2 in		
Y2/150/R	Y2/150/R/AN	Y2/150/R/BL		100x150 cm 39.3x60 in		
Y2/200/R	Y2/200/R/AN	Y2/200/R/BL		120x200 cm 47.2x78.7 in		
Y2/250/R	Y2/250/R/AN	Y2/250/R/BL		120x250 cm 47.2x96.7 in		

MORE DETAILS ABOUT THE SUPPORTS

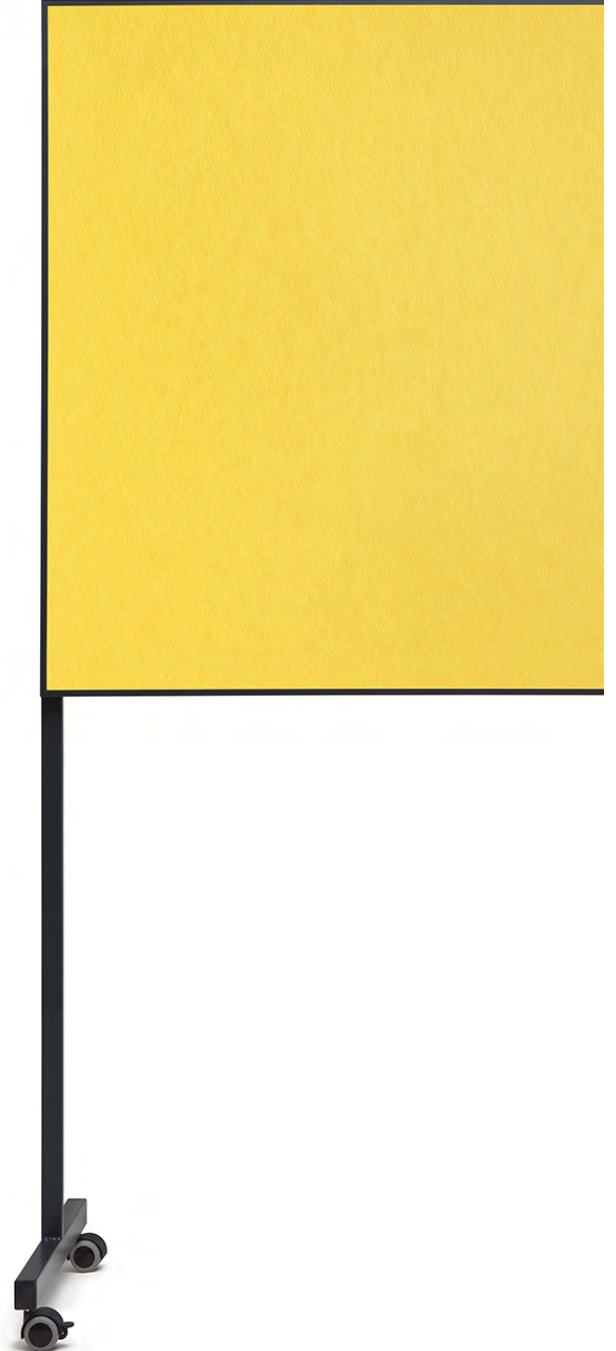
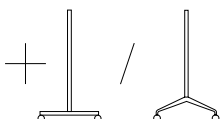

→ VIEW ON PAGE: 92

Screen Acoustic Panel



Sound absorbing panels for table dividers. Framed with a matt silver anodized aluminium profile these panels have a high percentage of recycled PET: 60% recycled polyester fibers from plastic bottles and 40% from new polyester fibers. Acoustic properties: alpha m: 0.25. NRC: 0.30. 0.9mm PET thickness. Available in 7 colours.

Separador fonoabsorbente para divisorias en mesas. Enmarcado con perfil de aluminio anodizado plata mate y panel con alto porcentaje de PET reciclado: 60% fibras de poliéster reciclado de botellas de plástico y 40% de nuevas fibras de poliéster. Propiedades acústicas: alpha m: 0,25. NRC: 0,30. Grosor de PET 0,9 mm. Disponible en 7 colores.

Panneau acoustique phono-absorbant pour séparer les tables. Composé d'un profil en aluminium anodisé argent mat et d'un panneau avec un pourcentage élevé de PET recyclé: 60% de fibres de polyester recyclées à partir de bouteilles en plastique et 40% de nouvelles fibres de polyester. Propriétés acoustiques: alpha m: 0,25. NRC: 0,30. Epaisseur du PET de 0,9 mm. Disponible en 7 couleurs.

Sizes

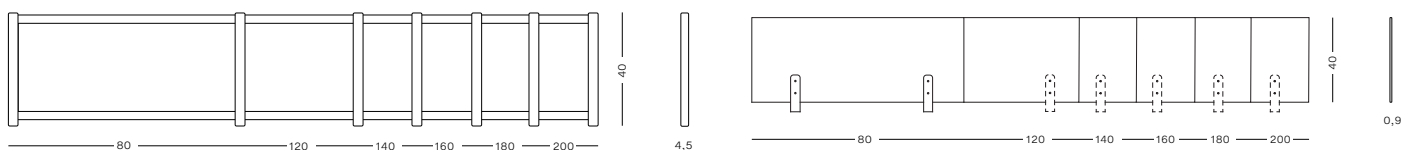

Specs



Colours





Screen Acoustic Panel

Aluminium frame

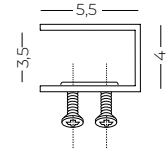
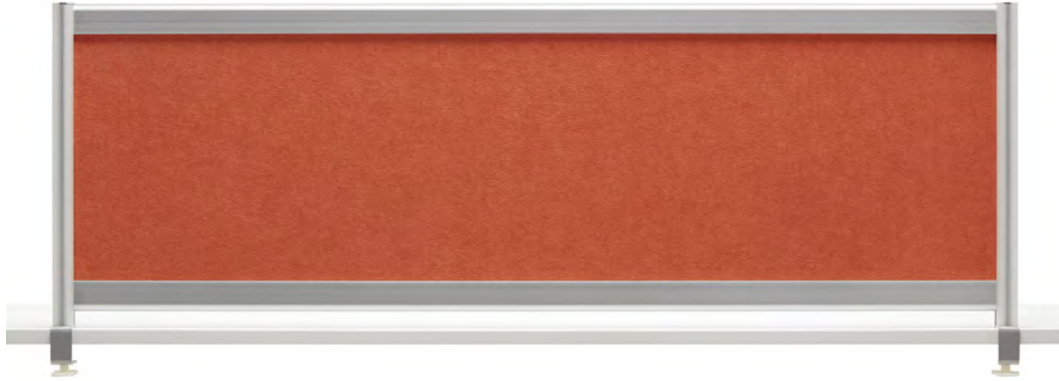
Grippers sizes

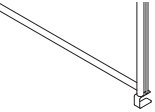

SCREEN	FRAME				ALPHA M	↔
	REF	PFA COLOUR				
	SEP/FA/80	● /NG	40x80 cm 15.7x31.4 in	2,7 Kg 5.5 £	0,25	4,5 cm 1.7 in
	SEP/FA/120	● /GR	40x120 cm 15.7x47.2 in	3,9 Kg 8.5 £	0,25	
	SEP/FA/140	● /AN	40x140 cm 15.7x55.1 in	4,5 Kg 9.9 £	0,25	
	SEP/FA/160	● /NJ	40x160 cm 15.7x62.9 in	5 Kg 11 £	0,25	
	SEP/FA/180	● /AM	40x180 cm 15.7x70.8 in	6 Kg 13.2 £	0,25	
	SEP/FA/200	● /AZ	40x200 cm 15.7x78.7 in	6,5 Kg 14.3 £	0,25	
		● /VD				



No frame



Grippers sizes

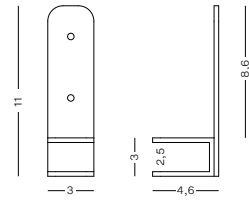

REF $\updownarrow \leftrightarrow$
 EP/PZ/3 11x3x4,6 cm KIT 2 CLAMPS
 15.7x31.4 in

SCREEN

NO FRAME

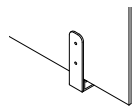

REF	PFA COLOUR	$\updownarrow \leftrightarrow$		ALPHA M
SEP/FP/80	● /NG	40x80 cm 15.7x31.4 in	0,7 Kg 1.6 £	0,25
SEP/FP/120	● /GR	40x120 cm 15.7x47.2 in	0,9 Kg 1.9 £	0,25
SEP/FP/140	● /NJ	40x140 cm 15.7x55.1 in	1 Kg 2,3 £	0,25
SEP/FP/160	● /AM	40x160 cm 15.7x62.9 in	1,2 Kg 2.6 £	0,25
SEP/FP/180	● /AZ	40x180 cm 15.7x70.8 in	1,3 Kg 3 £	0,25
SEP/FP/200	● /VD	40x200 cm 15.7x78.7 in	1,5 Kg 3.3 £	0,25

0,9 cm
0.3 in



Limit Acoustic Screen



Limit acoustic screens made with anodized aluminium profile available anodized in matt silver, or lacquered in anthracite and white, with matching metal trapezoidal feet. Panel surface with a high percentage of recycled PET: 60% recycled polyester fibers from plastic bottles and 40% from new polyester fibers. Acoustic properties: alpha m: 0.25. NRC: 0.30. 0.9mm PET thickness. Available in 7 colours.

Mampara Limit acústica fabricada con perfil de aluminio anodizado disponible en plata mate, o lacado en antracita y blanco, con pies trapezoidales metálicos a juego. Superficie del panel con alto porcentaje de PET reciclado: 60% fibras de poliéster reciclado de botellas de plástico y 40% de nuevas fibras de poliéster. Propiedades acústicas: alpha m: 0,25. NRC: 0,30. Grosor de PET 0,9 mm. Disponible en 7 colores.

Cloison acoustique « Limit » avec profil en aluminium anodisé disponible en argent mat, ou laqué en anthracite et blanc, avec pieds trapézoïdaux en métal assortis. Surface du panneau avec un pourcentage élevé de PET recyclé: 60% de fibres de polyester recyclées à partir de bouteilles en plastique et 40% de nouvelles fibres de polyester. Propriétés acoustiques: alpha m: 0,25. NRC: 0,30. Epaisseur du PET de 0,9 mm. Disponible en 7 couleurs.



Limit Acoustic Screen

Sizes

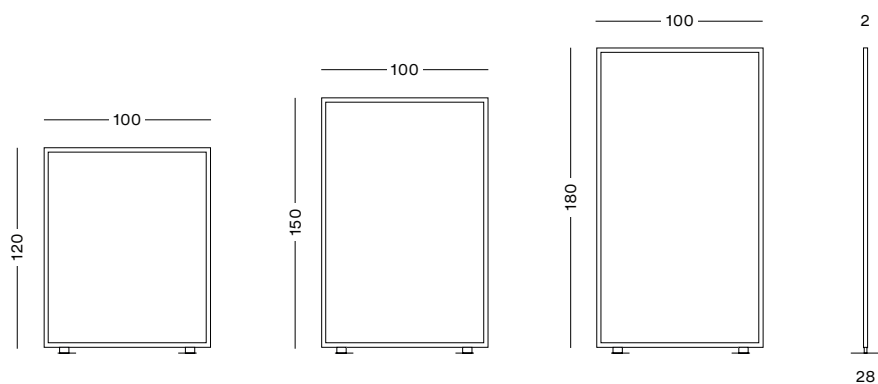

Aluminium frame



Specs



Colours



Colour frames



ACCESSORIES

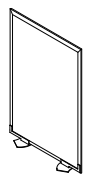

Color	Model	Dimensions (cm)	Dimensions (in)	Weight (Kg)	Price (£)
●	300/1/FA	120x100	47.2x39.3	10	22.04
●	300/2/FA	150x100	59.05x39.3	12,4	27.33
●	300/3/FA	180x100	70.8x39.3	14,9	32.84

REF	Dimensions (cm)	Dimensions (in)	Quantity
300/K	2x5	0.78x1.96	2
300/K/4	5x5	1.96x1.96	4

Other finishes

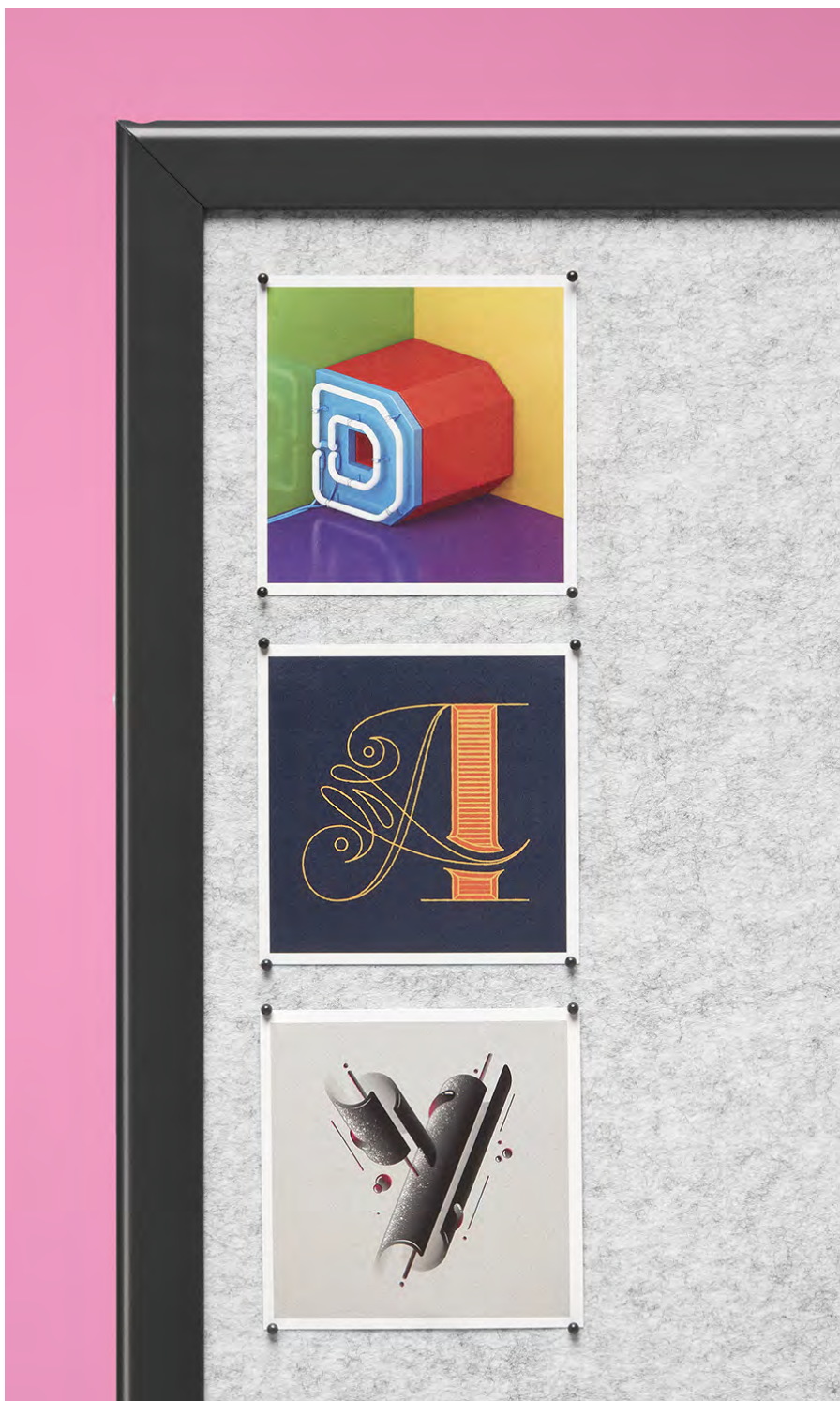

Acrylic Screen [VIEW ON PAGE: 194](#)



Writeboard Screen [VIEW ON PAGE: 80](#)

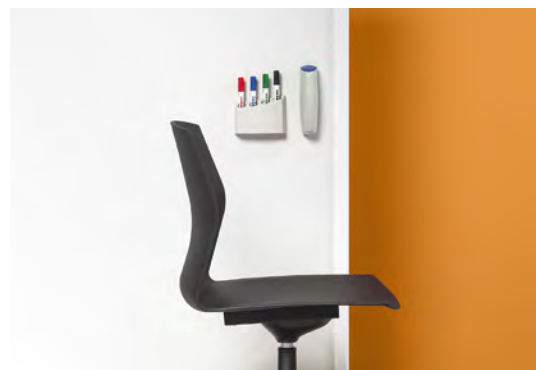

Antibacterial Screen [VIEW ON PAGE: 198](#)



Ten Limit Acoustic Screen



Acoustic Ten Limit screen made from anodized aluminium profile available in matt silver, or lacquered in anthracite and white, with Y2 cast aluminium feet with wheels. Panel surface with a high percentage of recycled PET: 60% recycled polyester fibers from plastic bottles and 40% from new polyester fibers. Acoustic properties: alpha m: 0.25. NRC: 0.30. 0.9mm PET thickness. Available in 7 colours.

Mampara Ten Limit acústica fabricada con perfil de aluminio anodizado, disponible en plata mate, o lacado en antracita y blanco, con pies Y2 de fundición de aluminio con ruedas. Superficie del panel con alto porcentaje de PET reciclado: 60% fibras de poliéster reciclado de botellas de plástico y 40% de nuevas fibras de poliéster. Propiedades acústicas: alpha m: 0,25. NRC: 0,30. Grosor de PET 0,9 mm. Disponible en 7 colores.

Cloison acoustique Ten Limit avec un profile d'aluminium disponible anodisé en argent mat, ou laqué en anthracite et blanc, avec pieds roulettes en aluminium moulé Y2. Surface du panneau avec un pourcentage élevé de PET recyclé: 60% de fibres de polyester recyclées à partir de bouteilles en plastique et 40% de nouvelles fibres de polyester. Propriétés acoustiques: alpha m: 0,25. NRC: 0,30. Epaisseur du PET de 0,9 mm. Disponible en 7 couleurs.



Ten Limit Acoustic Screen

Sizes

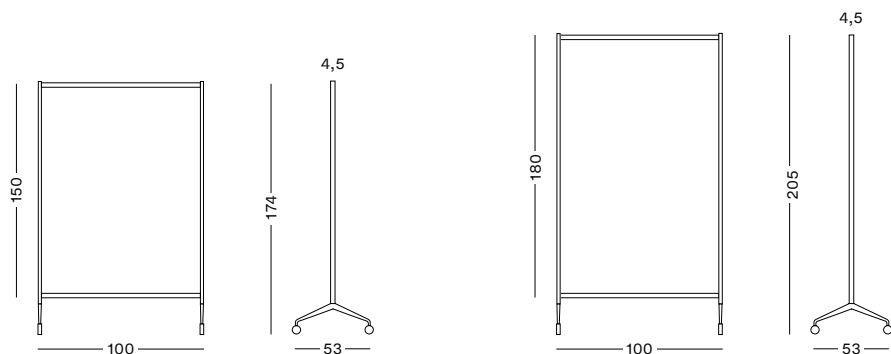

Aluminium frame



Specs



Colours

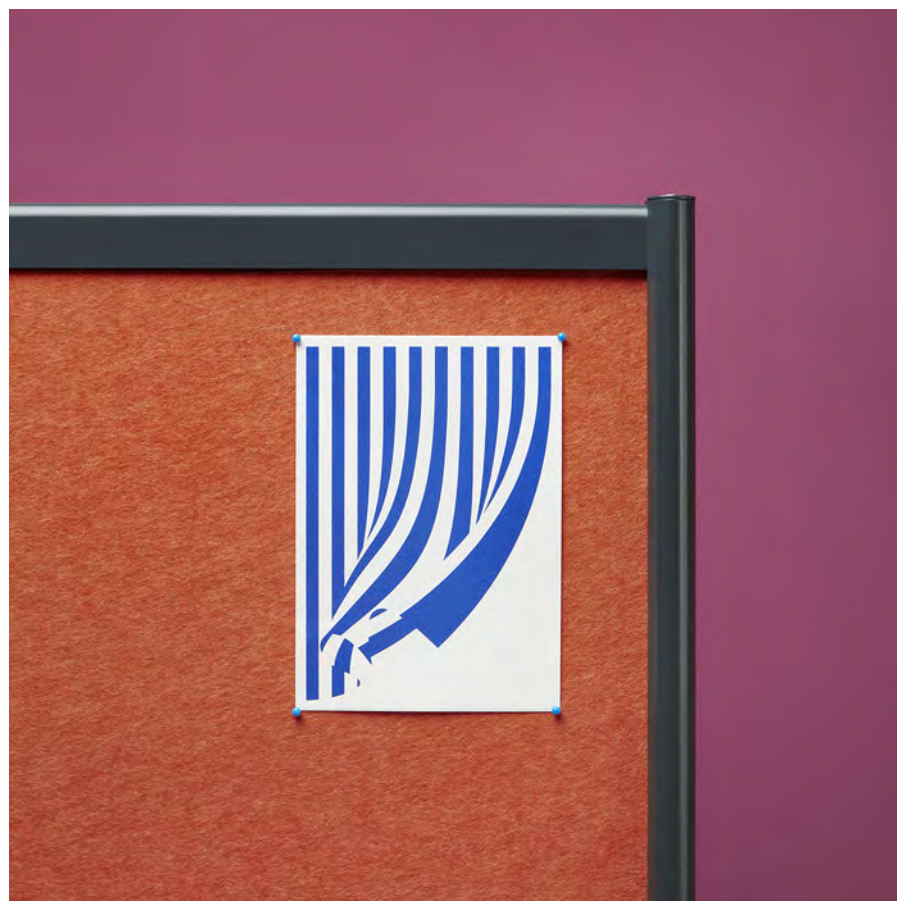
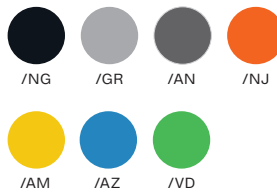

Colour frames



SUPPORT

↔ SCREEN

↔ SUPPORT



●	●	○
TL/150/FA	TL/150/FA/AN	TL/150/FA/BL
TL/180/FA	TL/180/FA/AN	TL/180/FA/BL

↕ ↔ SCREEN
150x100 cm 59,05x39,3 in
180x100 cm 70,8x39,3 in

↕
175 cm 68.8 in
205 cm 80.7 in

⚖
8 Kg 17.6 £
9 Kg 19.8 £

4,5 cm 1.7 in

53 cm 20.8 in



Foam Acoustic



Acoustic panels made from 4cm thick foam available as standard in white or painted (30 colors) from the Ral chart. They avoid reverberation in offices, premises, restaurants, etc ... As well as in large covered spaces such as shopping centers or sports halls. They are fitted by suspension or fixing glue on ceilings or walls. Ideal for improving acoustics.

Paneles acústicos fabricados en Foam espumado de 4 cm de grosor disponibles estándar en blanco o pintados (30 colores) de la carta Ral. Evitan la reverberación en oficinas, locales, restaurantes, etc... Así como en grandes espacios cubiertos tales como centros comerciales o pabellones deportivos. Se aplican mediante suspensión o cola de fijación en techos o paredes. Ideales para mejorar el confort acústico.

Panneaux acoustiques en mousse expansée de 4 cm d'épaisseur disponibles en standard en blanc ou peints (30 couleurs) à partir du nuancier Ral. Ils évitent la réverbération des sons dans les bureaux, locaux, restaurants, etc ... Ainsi que dans les grands espaces couverts tels que les centres commerciaux ou les salles de sport. Ils sont appliqués par suspension ou avec une colle de fixation sur des plafonds ou des murs. Idéal pour améliorer le confort acoustique.

Sizes

BASIC

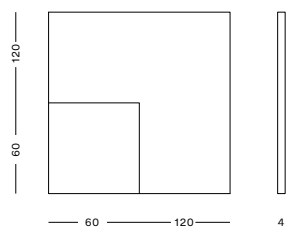

TECHNICAL CEILING

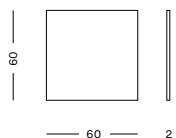

RECTANGLE

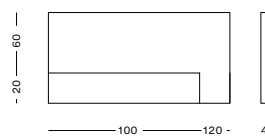

CIRCLE

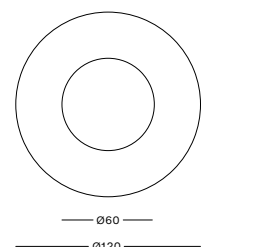

BAFFLE

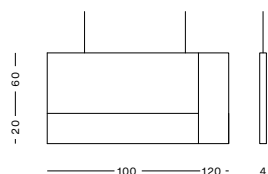

CURVED BAFFLE

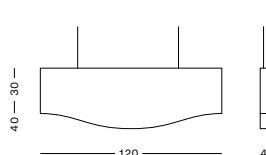

CONVEX

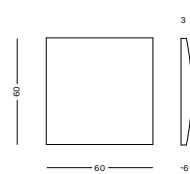

CYLINDER



Colours (ral)

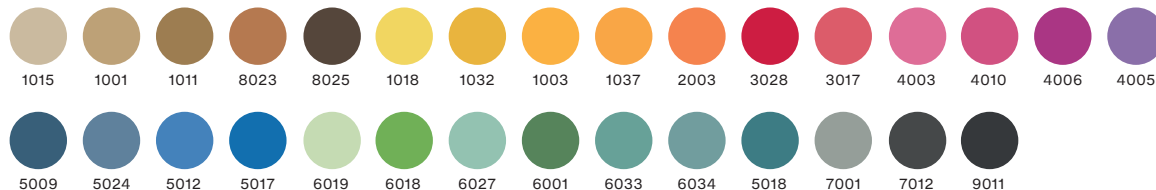

Specs



Foam Acoustic

Basic

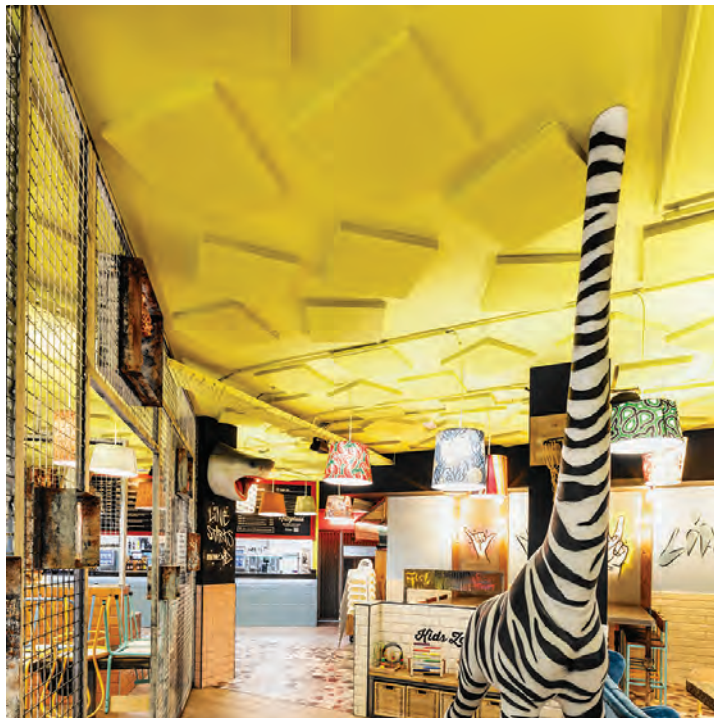

Technical Ceiling

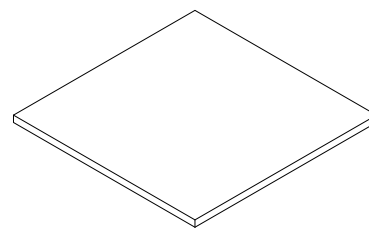
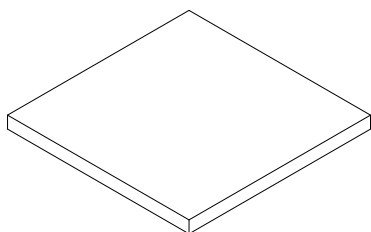

Data

REF	↔ ↕	⇒ ⇐	👤	⊙
PFA/BAS/01/BL	60x60 cm 23.6x23.6 in	4 cm 1.5 in	0,14 Kg 0.3 £	/BL
PFA/BAS/02/BL	120x120 cm 47.2x47.2 in	4 cm 1.5 in	0,58 Kg 1.2 £	

COLOR VERSION

REF	↔ ↕	⇒ ⇐	👤
PFA/BAS/01/CO	60x60 cm 23.6x23.6 in	4 cm 1.5 in	0,37 Kg 0.8 £
PFA/BAS/02/CO	120x120 cm 47.2x47.2 in	4 cm 1.5 in	1,52 Kg 3.3 £

Data

REF	↔ ↕	⇒ ⇐	👤	⊙
PFA/TT/01/BL	60x60 cm 23.6x23.6 in	2 cm 0.7 in	0,07 Kg 0.1 £	/BL

COLOR VERSION

REF	↔ ↕	⇒ ⇐	👤
PFA/TT/01/CO	60x60 cm 23.6x23.6 in	2 cm 0.7 in	0,3 Kg 0.6 £

Rectangle



Circle

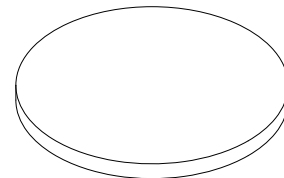
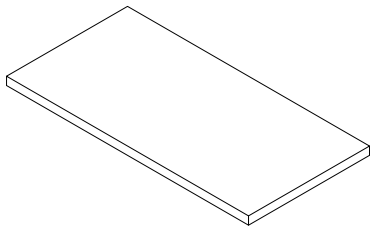

Data

REF	↔↕	⇒⇐	👤	⊙	COLOURS
PFA/REC/01/BL	100x20 cm 39.3x7.8 in	4 cm 1.5 in	0,08 Kg 0.1 £	/BL	
PFA/REC/02/BL	120x60 cm 47.2x23.6 in	4 cm 1.5 in	0,29 Kg 0.6 £		

 COLOR VERSION

REF	↔↕	⇒⇐	👤	COLOURS
PFA/REC/01/CO	100x20 cm 39.3x7.8 in	4 cm 1.5 in	0,21 Kg 0.4 £	
PFA/REC/02/CO	120x60 cm 47.2x23.6 in	4 cm 1.5 in	0,45 Kg 0.9 £	

Data

REF	∅	⇒⇐	👤	⊙	COLOURS
PFA/CIR/01/BL	∅60 cm ∅23.6 in	4 cm 1.5 in	0,11 Kg 0.2 £	/BL	
PFA/CIR/02/BL	∅120 cm ∅47.2 in	4 cm 1.5 in	0,45 Kg 0.9 £		

 COLOR VERSION

REF	∅	⇒⇐	👤	COLOURS
PFA/CIR/01/CO	∅60 cm ∅23.6 in	4 cm 1.5 in	0,31 Kg 0.6 £	
PFA/CIR/02/CO	∅120 cm ∅47.2 in	4 cm 1.5 in	1,18 Kg 2.6 £	

Foam Acoustic

Baffle

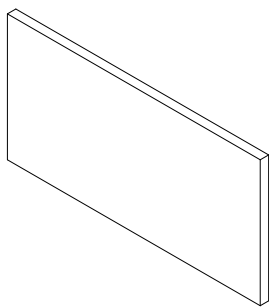

Data

REF	↔↕	→←	⚖	○
PFA/BAF/01/BL	100x20 cm 39.3x7.8 in	4 cm 1.5 in	0,08 Kg 0.17 £	/BL
PFA/BAF/02/BL	120x60 cm 47.2x23.6 in	4 cm 1.5 in	0,29 Kg 0.63 £	

COLOR VERSION

REF	↔↕	→←	⚖
PFA/BAF/01/CO	100x20 cm 39.3x7.8 in	4 cm 1.5 in	0,34 Kg 0.74 £
PFA/BAF/02/CO	120x60 cm 47.2x23.6 in	4 cm 1.5 in	1,22 Kg 2.68 £

Curved Baffle

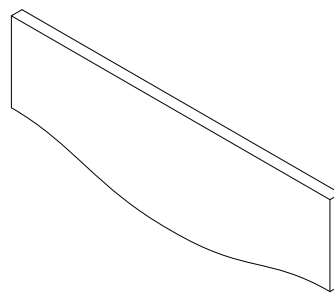

Data

REF	↔↕	→←	⚖	○
PFA/BAC/01/BL	120x30/40 cm 47.2x11.8/15.7 in	4 cm 1.5 in	0,17 Kg 0.37 £	/BL

COLOR VERSION

REF	↔↕	→←	⚖
PFA/BAC/01/CO	120x30/40 cm 47.2x11.8/15.7 in	4 cm 1.5 in	0,71 Kg 1.56 £

Cylinder



Convex

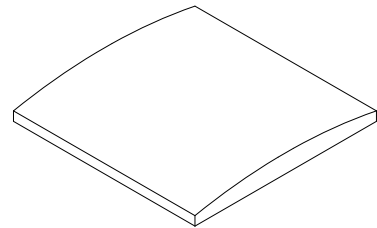
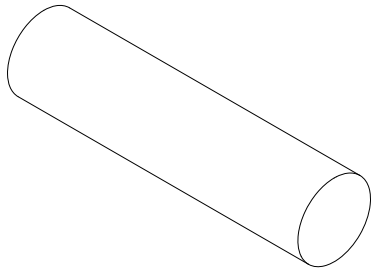

Data

REF	∅	↔	⚖	○
PFA/CIL/01/BL	∅12,5 cm ∅4.9 in	50 cm 19.6 in	0,06 Kg 1.1 £	/BL

COLOURS

COLOR VERSION

REF	∅	↔	⚖
PFA/CIL/01/CO	∅12,5 cm ∅4.9 in	50 cm 19.6 in	0,2 Kg 0.4 £

Data

REF	↔↕	↗↖	⚖	○
PFA/CON/01/BL	60x60 cm 23.6x23.6 in	6/3 cm 2.3/1.2 in	0,16 Kg 0.3 £	/BL

COLOURS

COLOR VERSION

REF	↔↕	↗↖	⚖
PFA/CON/01/CO	60x60 cm 23.6x23.6 in	6/3 cm 2.3/1.2 in	0,4 Kg 0.8 £

R · PET Panel



Acoustic panels made from recycled PET: 60% recycled polyester fibers from plastic bottles and 40% from new polyester fibers. Acoustic properties: alpha m: 0.25. NRC: 0.30. PET thickness 1.2 cm. Available in 10 standard colors. Upon request they can be done in nonstandard Ral colours (special). They avoid reverberation in offices, premises, restaurants, etc ... As well as in large covered spaces such as shopping centers or sports halls. They are fitted by suspension or fixing glue on ceilings or walls. Ideal for improving acoustic comfort.

Paneles acústicos fabricados en PET reciclado: 60% fibras de poliéster reciclado de botellas de plástico y 40% de nuevas fibras de poliéster. Propiedades acústicas: alpha m: 0,25. NRC: 0,30. Grosor de PET 1,2 cm. Disponible en 10 colores estándar. Bajo pedido pueden pintarse en la carta Ral deseada. Evitan la reverberación en oficinas, locales, restaurantes, etc... Así como en grandes espacios cubiertos tales como centros comerciales o pabellones deportivos. Se aplican mediante suspensión o cola de fijación en techos o paredes. Ideales para mejorar el confort acústico.

Panneaux acoustiques en PET recyclé: 60% de fibres de polyester recyclées à partir de bouteilles en plastique et 40% de nouvelles fibres de polyester. Propriétés acoustiques: alpha m: 0,25. NRC: 0,30. Epaisseur du PET 1,2 cm. Disponible en 10 couleurs standard. Sur demande, ils peuvent être peints dans le tableau Ral souhaité. Ils évitent les réverbérations dans les bureaux, locaux, restaurants, etc ... Ainsi que dans les grands espaces couverts tels que les centres commerciaux ou les salles de sport. Ils sont appliqués par suspension ou avec une colle de fixation sur des plafonds ou des murs. Idéal pour améliorer le confort acoustique.

Sizes

SQUARE ISLAND

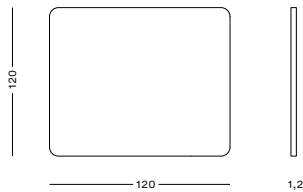

CIRCULAR ISLAND

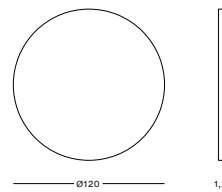

3D ISLAND

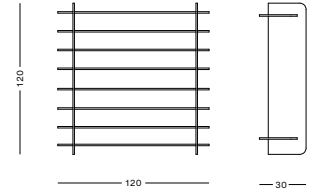

WALL PANEL

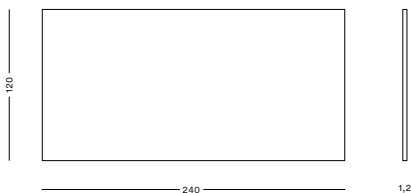

DIVIDER PANEL

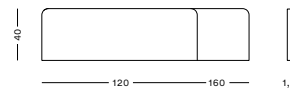

PERSONAL DESK DIVIDER

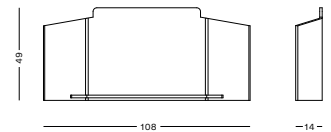

R·PET Colours



Specs



R · PET Panel

Square Island

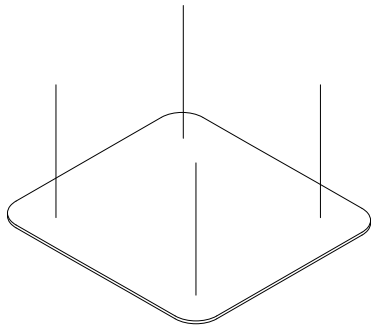

Data

REF
PET/ISL/01

↔↕
120x120 cm
47.2x47.2 in

↔↕
1,2 cm
0.4 in

⚖️
4,22 Kg
9.3 £

R·PET COLOURS



Circular Island

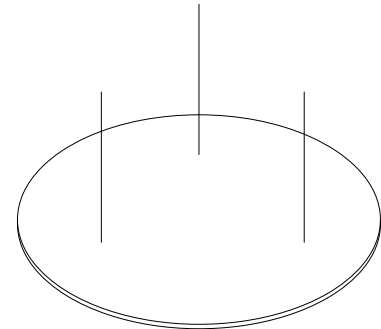

Data

REF
PET/ISC/01

∅
Ø120 cm
Ø47.2 in

↔↕
1,2 cm
0.4 in

⚖️
3,3 Kg
7.2 £

R·PET COLOURS



3D Island



Wall Panel

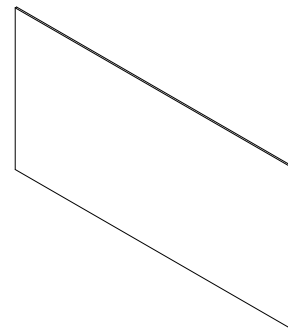
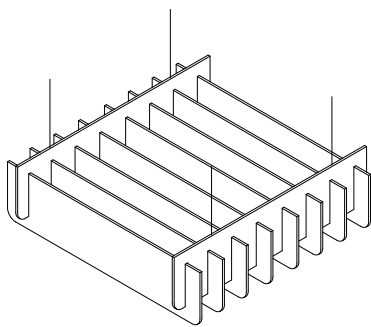
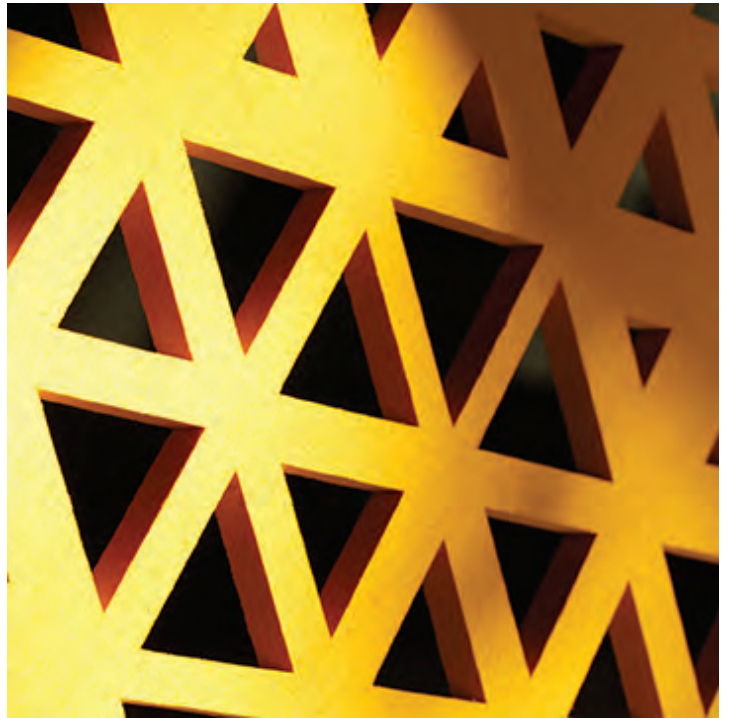

Data

REF
PET/ISL3/01

↔↕
120x120 cm
47.2x47.2 in

↕
30 cm
11.8 in

⚖️
5,4 Kg
12 £

R·PET COLOURS



Data

REF
PET/WP/01

↔↕
240x120 cm
94.4x47.2 in

↔↔
1,2 cm
0.4 in

⚖️
6,5 Kg
14.4 £

R·PET COLOURS



R · PET Panel

Divider Panel

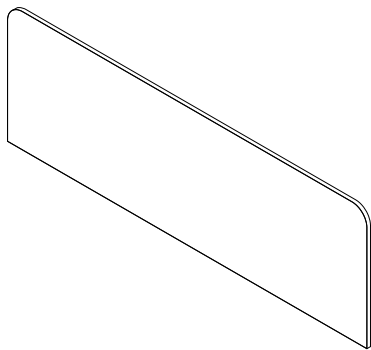

Data

REF	↔ ↕	⇒ ⇐	👤
PET/SEP/01	120x40 cm 47.2x15.7 in	1,2 cm 0.4 in	1 Kg 2.2 £
PET/SEP/02	160x40 cm 62.9x15.7 in	1,2 cm 0.4 in	1,4 Kg 3 £

R · PET COLOURS



Personal Desk Divider

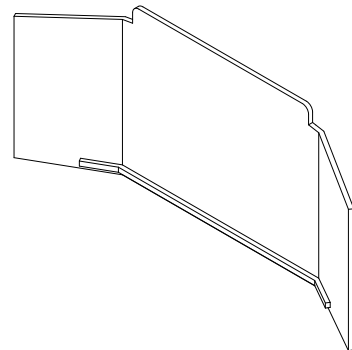

Data

REF	↔ ↕	⇒ ⇐	👤
PET/DES/01	108x49 cm 42.5x19.2 in	13 cm 5.1 in	1,2 Kg 2.6 £

R · PET COLOURS



Accessories

Table clamp kit
Kit pinzas de mesa
Kit de pinces de table

ACC/PFA/01



Table clamp kit
Kit pinzas de mesa
Kit de pinces de table

ACC/PFA/02



Suspension kit 2m.
Kit de suspensión 2 m.
Kit de suspension 2 m.

ACC/PFA/03



Glue bottle (290 ml)
Tubo de cola (290 ml)
Bouteille de colle (290 ml)

ACC/PFA/04



Protect

Suspended Screen	172
Electric Suspended Screen	174
Acrylic Screen	176
Glass Screen	178
Extension Acrylic Screen	180
Ribbed Acrylic Screen	182
Glass Screen + Clamps	184
Ten Limit Acrylic Screen	186
Ten Limit Antibacterial Screen	190
Limit Acrylic Screen	194
Limit Antibacterial Screen	198
Gel Dispensers	202
Automatic Gel Dispensers	206
Outdoor Gel Dispensers	210
Acces Control	214

Having a beautiful and aesthetic product that helps us with social distancing, or in health & safety as well as hygiene that this new reality that we are living requires of us, should not be a luxury. There are products that have come to stay and will live with us for a long time. In Planning Sisplamo from the beginning we got straight to work developing an extensive range of products that help us in a practical and functional way in this task. Since we must have it, let's do it right.



Tener un producto bonito y estético que nos ayude en este distanciamiento social, o en la protección e higiene que esta nueva realidad que estamos viviendo nos obliga, no debe ser un lujo. Hay productos que han venido para quedarse y van a convivir con nosotros durante mucho tiempo. En Planning Sisplamo desde un inicio nos pusimos manos a la obra para desarrollar una extensa gama de productos que nos ayuden de manera práctica y funcional en este cometido. Ya que debemos tenerlo, tengámoslo bien.

Avoir un beau produit utile et esthétique qui nous aide dans cette distanciation sociale, ou dans la protection et l'hygiène qu'exige cette nouvelle réalité que nous vivons, ne doit pas être un luxe. Il y a des produits qui sont venus pour rester et qui vivront avec nous pendant longtemps. Chez Planning Sisplamo depuis le début, nous nous sommes mis au travail pour développer une large gamme de produits qui nous aident de manière pratique et fonctionnelle dans ces tâches au quotidien. Puisque nous devons l'utiliser, faisons les choses correctement.

Distancia de Seguridad

Suspended Screen

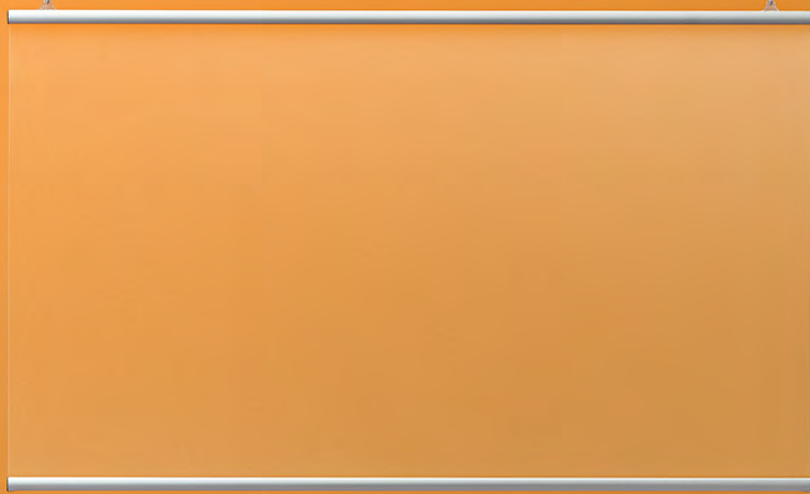

Suspended screen Top made of 1 / 0.7 mm PVC Crystal plastic. transparent, provided with anodized aluminum profile in matt silver upper and lower . It includes plastic side covers and a set of 2 meter braided steel cables and hardware for fixing to the ceiling. Clean with a dry cloth and neutral detergent.

Mampara suspendida Top fabricada en plástico PVC Cristal de 1/0,7 mm. transparente, provista de perfil de aluminio anodizado en plata mate en su parte superior e inferior. Incluye tapetas laterales de plástico y juego de cables de acero trenzado de 2 metros y herrajes para fijación a techo. Limpiar con paño seco y detergente neutro.

Cloison suspendue TOP fabriquée en PVC 1 / 0,7 mm. transparente, pourvue d'un profil en aluminium anodisé en argent mat sur sa partie supérieure et inférieure. Il comprend des couvercles latéraux en plastique et un ensemble de câbles en acier tressé de 2 mètres et du matériel pour la fixation au plafond. Nettoyer avec un chiffon sec et un détergent neutre.

Sizes

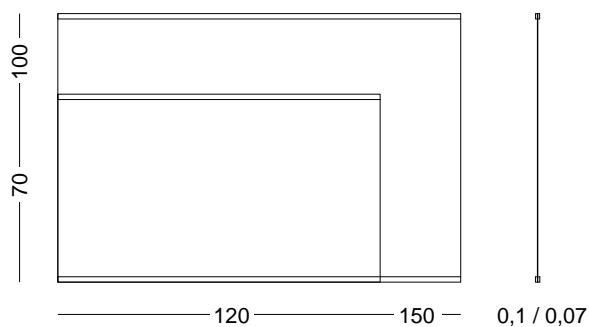

Specs



Aluminium frame



SUSPENDED

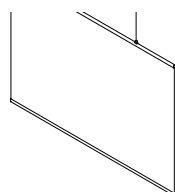

REF	↔ ↓	↗ ↖	⚖
EP/MST/120	120x70 cm 47.2x27.5 in	0,07 cm 0.02 in	2,3 Kg 5.5 £
EP/MST/150	150x100 cm 59x39.3 in	0,1 cm 0.04 in	4,2 Kg 9.2 £

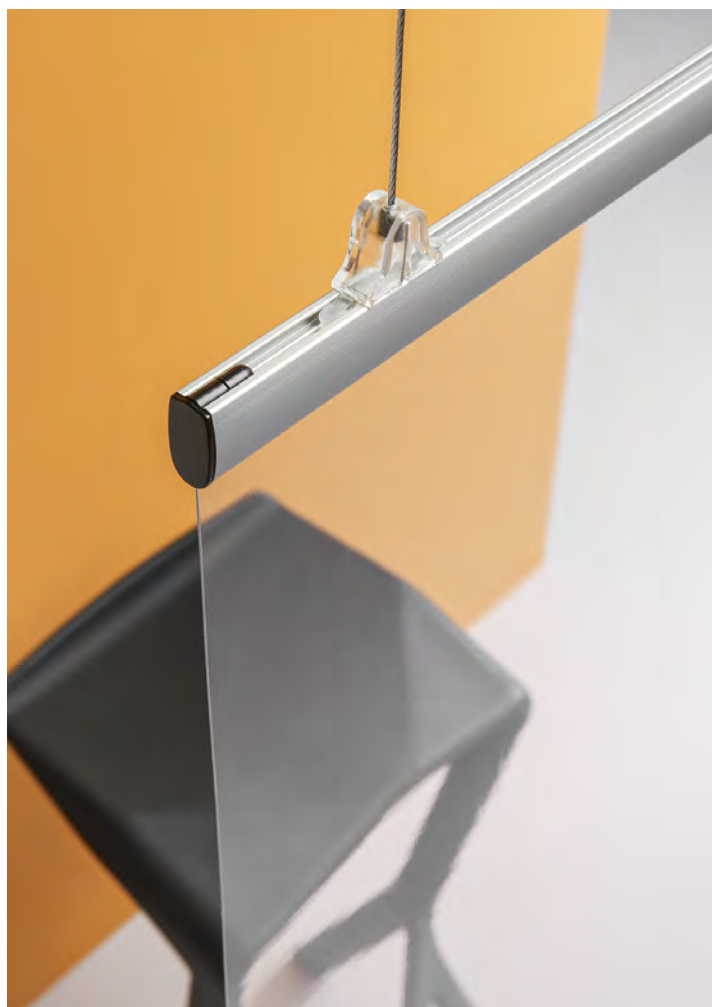

Electric Suspended Screen

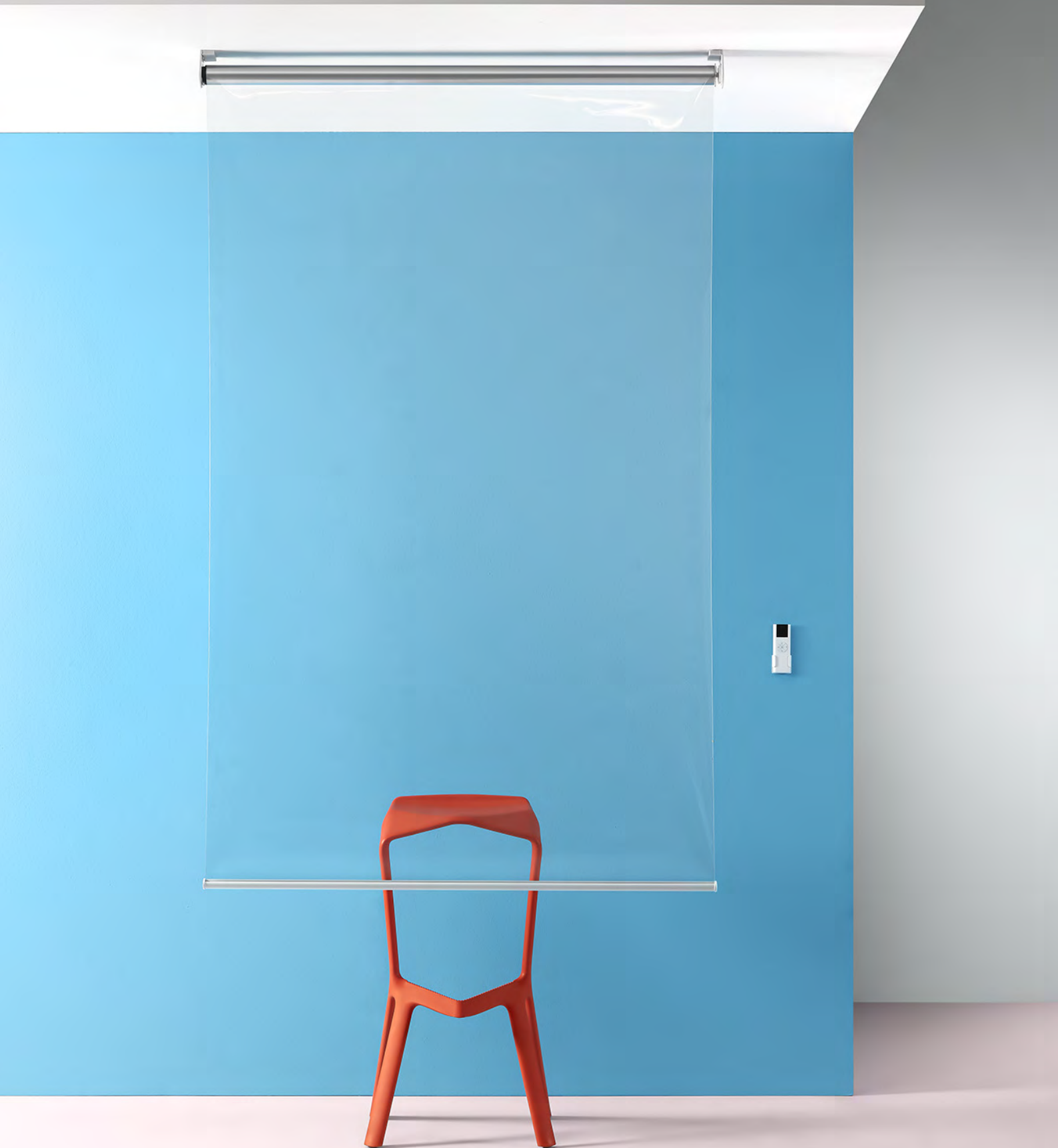

Suspended electric roll-up screen from ceiling operated by remote control (included). It works with a lithium battery. No installation required. Made of 1mm transparent polyester plastic. The screen has a maximum drop measure of 2 meters, being able to adjust it to the desired height. Available in two widths. Clean with a dry cloth and neutral detergent.

Mampara suspendida eléctrica enrollable a techo accionada mediante mando a distancia incluido. Funciona con batería de litio. No precisa instalación. Fabricada con plástico poliéster transparente de 1 mm. La mampara tiene una medida máxima de caída de 2 metros, pudiéndola ajustar a la altura deseada. Disponible en dos medidas de ancho. Limpiar con paño seco y detergente neutro.

Cloison électrique suspendue, au plafond actionnée par télécommande (télécommande incluse). Le système fonctionne avec une batterie au lithium. Aucune installation requise. Fabriquée en plastique polyester transparent de 1 mm. L'écran descend jusqu'à 2 mètres, ce qui lui permet d'être ajusté à la hauteur désirée. Disponible en deux largeurs. Nettoyer avec un chiffon sec et un détergent neutre.

Sizes

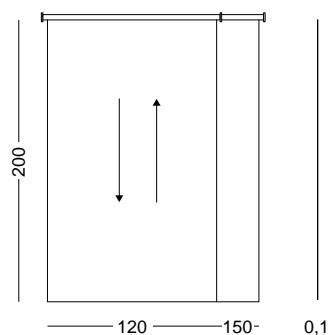

Specs



Roll-up screen

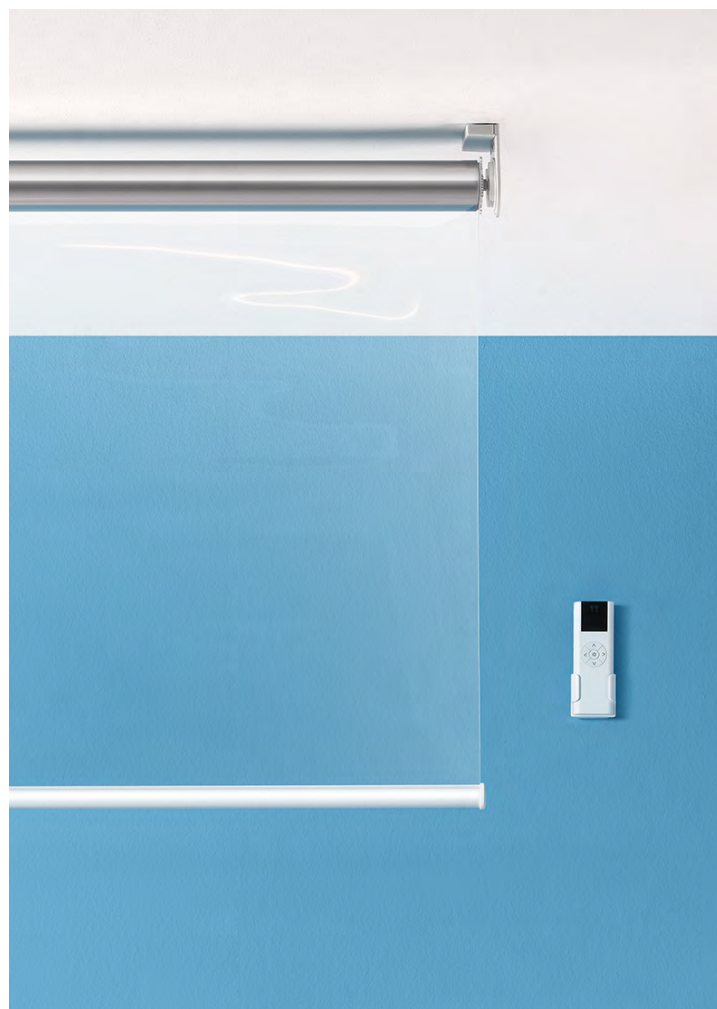
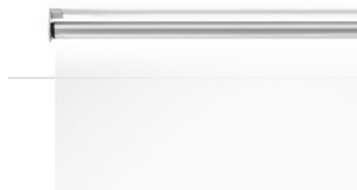

SUSPENDED

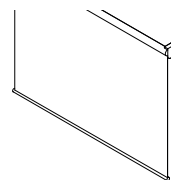

REF	↔ ↓	↗ ↖	⚖
EP/MEE/120	120x200 cm 47.2x78.7 in	0,1 cm 0.3 in	3,5 Kg 7.7 £
EP/MEE/150	150x200 cm 59x78.7 in	0,1 cm 0.04 in	3,8 Kg 8.3 £

Accessories



EP/MEE/CAR
Charger
Cargador
Chargeur

Acrylic Screen



Mobile removable desktop screen made from 3 mm PET. Equipped with two feet, ideal for placing on front counters at shops and public places as well as in offices to separate and give safety to the staff at work. Available in 3 sizes and option of with or without window. Clean with a dry cloth and neutral detergent.

Mampara móvil de sobremesa desmontable fabricada en PET de 3 mm. Dotada de dos pies, ideal para ubicar en los mostradores de tiendas y establecimientos cara al público, así como en oficinas para separar y dar seguridad a las personas que las habitan. Disponibles en 3 medidas y opción de con o sin ventanilla. Limpiar con paño seco y detergente neutro.

Cloison de bureau mobile amovible en PET de 3 mm. Équipée de deux pieds, elle est idéale pour être placée sur les comptoirs des commerces et les établissements publics, ainsi que dans des bureaux pour séparer et sécuriser les personnes qui les côtoient. Disponible en 3 tailles, avec ou sans fenêtre. Nettoyer avec un chiffon sec et un détergent neutre.

Sizes

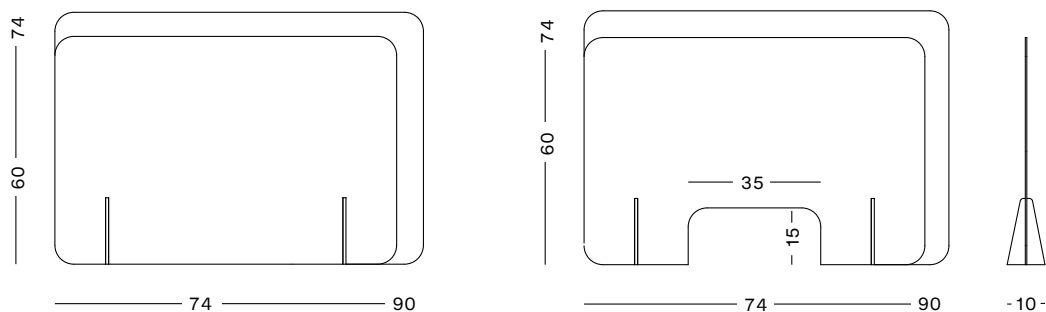

Specs

Options



NO WINDOW

REF	↔ ↓	↗ ↖	⚖
EP/MM/74/60	74x60 cm 29.1x23.6 in	0,3 cm 0.1 in	3 Kg 6.6 £
EP/MM/90/60	90x60 cm 35.4x23.6 in	0,3 cm 0.1 in	3,1 Kg 6.8 £
EP/MM/90/74	90x74 cm 35.4x29.1 in	0,3 cm 0.1 in	3,2 Kg 7 £

WITH WINDOW

REF	↔ ↓	↗ ↖	⚖
EP/MMV/74/60	74x60 cm 29.1x23.6 in	0,3 cm 0.1 in	3Kg 6.7 £
EP/MMV/90/60	90x60 cm 35.4x23.6 in	0,3 cm 0.1 in	3,1 Kg 6.9 £
EP/MMV/90/74	90x74 cm 35.4x29.1 in	0,3 cm 0.1 in	3,2 Kg 7 £



Glass Screen



Mobile screen made from 6mm clear laminated glass. (3 + 3 mm. Approved), with removable white lacquered metal supports. Includes security screw and anti-slip system. Ideal for placing on counters at shops and receptions facing the public, as well as in offices to separate and give safety to employees. Available in 2 sizes and option of with or without window. Clean with a dry cloth and neutral detergent.

Mampara móvil fabricada en cristal laminado incoloro de 6 mm. (3+3 mm. homologado), con soportes metálicos desmontables lacados en color blanco. Incluye tornillo de seguridad y sistema antideslizante. Ideal para ubicar en los mostradores de tiendas y establecimientos cara al público, así como en oficinas para separar y dar seguridad a las personas que las habitan. Disponibles en 2 medidas y opción de con o sin ventanilla. Limpiar con paño seco y detergente neutro.

Extension pour allonger un séparateur existant. Fabriqué en méthacrylate de 3 mm. S'adapte à l'aide de 3 supports peints en blanc de 15 x 35 mm, inclus dans le kit. Idéal pour les bureaux individuels et les établissements face au public, ainsi que dans les bureaux pour séparer et sécuriser les personnes qui les côtoient. Disponible en 2 tailles et option avec ou sans fenêtre. Nettoyer avec un chiffon sec et un détergent neutre.

Sizes

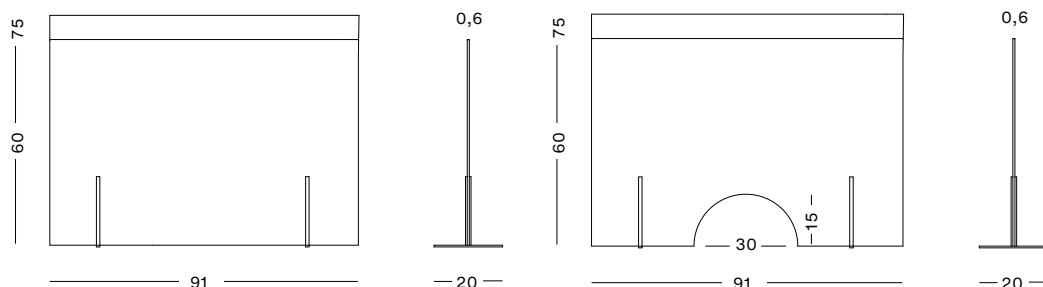

Specs



Options



NO WINDOW

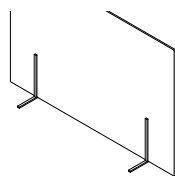

REF	↕ ↔	↗ ↘	⚖
EP/MCS/60/91	60x91 cm 23.6x35.8 in	0,6 cm 0.2 in	11 Kg 24.2 £
EP/MCS/75/91	75x91 cm 29.5x35.8 in	0,6 cm 0.2 in	12 Kg 26.4 £

WITH WINDOW

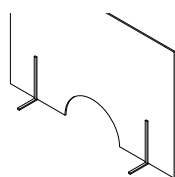

REF	↕ ↔	↗ ↘	⚖
EP/MCC/60/91	60x91 cm 23.6x35.8 in	0,6 cm 0.2 in	11 Kg 24.2 £
EP/MCC/75/91	75x91 cm 29.5x35.8 in	0,6 cm 0.2 in	12 Kg 26.4 £



Extension Acrylic Screen



Extension to lengthen an existing screens. Made of 3 mm methacrylate. Fits using 3 15 x 35mm white painted brackets. included in the kit. Ideal for offices and workstations made up of table islands. Clean with a dry cloth and a neutral detergent. Available in 3 sizes 30 cm high.

Extensión para alargar una mampara ya existente en un conjunto de mesas. Fabricada en metacrilato de 3 mm. Se adapta mediante 3 soportes pintados en blanco de 15 x 35 mm. incluidos en el kit. Ideal para oficinas y puestos de trabajo formados por islas de mesas. Limpiar con paño seco y un detergente neutro. Disponible en 3 tamaños de 30 cm de altura.

Extension pour allonger un écran existant. Fabriqué en méthacrylate de 3 mm. S'adapte à l'aide de 3 supports peints en blanc de 15 x 35 mm, inclus dans le kit. Idéal pour les bureaux individuelles et les bench. Nettoyer avec un chiffon sec et un détergent neutre. Disponible en 3 tailles 30 cm de hauteur.

Sizes

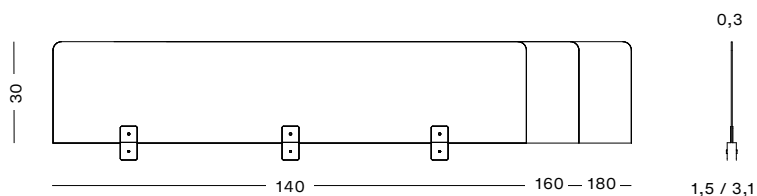

Specs



3 brackets

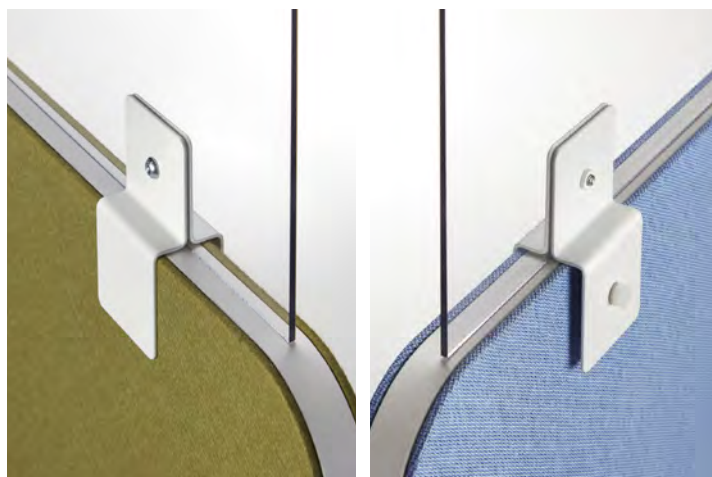

REF	↕ ↔	📏	0,3 cm 0.1 in
EP/EX/140	30x140x0,3 11.8x55.1x0.1	1,75 Kg 3.8 £	
EP/EX/160	30x160x0,3 11.8x63x0.1	2 Kg 4.4 £	
EP/EX/180	30x180x0,3 11.8x70.8x0.1	2,25 Kg 4.9 £	

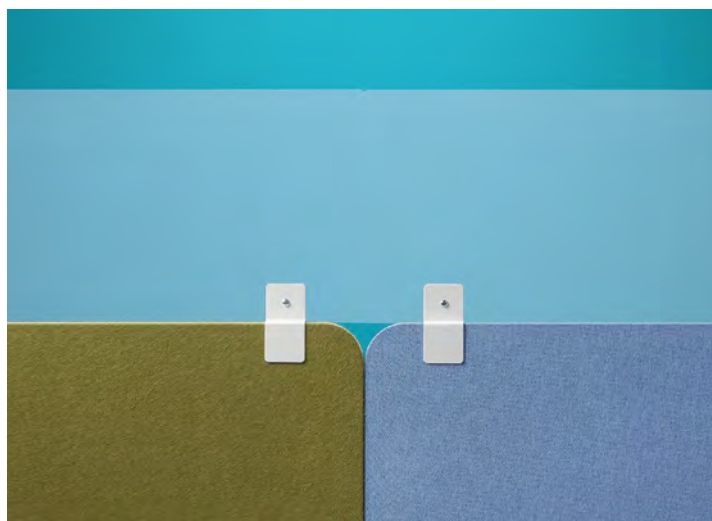

Ribbed Acrylic Screen



Desk Panel dividers made from ribbed polycarbonate in various transparency finishes. Framed with matt silver anodized aluminum profile. It is attached to the tabletop with adjustable metal clips. Ideal for offices and workstations and available in 6 sizes. Clean with a dry cloth and a neutral detergent.

Separador para divisorias en mesas fabricado en policarbonato acanalado en varios acabados de transparencia. Enmarcado con perfil de aluminio anodizado plata mate. Se sujeta al sobre de la mesa con unas pinzas graduables metálicas. Ideal para oficinas y puestos de trabajo y disponible en 6 medidas. Limpiar con paño seco y un detergente neutro.

Panneau séparateur de table en polycarbonate ondulé- disponible dans différentes finitions de transparence. Profil en aluminium anodisé argent mat. Il est fixé au dessus de la table avec des clips métalliques réglables. Idéal pour les bureaux et les postes de travail. Disponible en 6 tailles. Nettoyer avec un chiffon sec et un détergent neutre.

Sizes

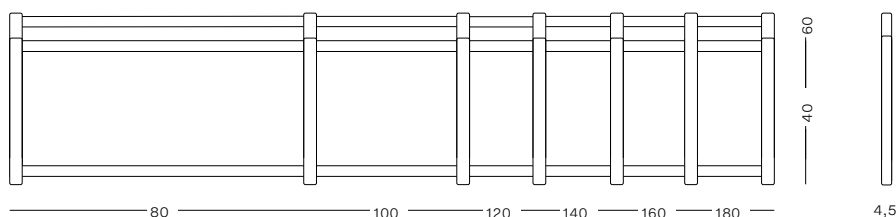

Options

RIBBED TRANSLUCENT

RUBBED SEMI TRANSPARENT

TRANSPARENT 100%



1



2



3

→ ←

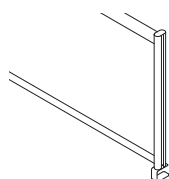

1

SEP/PX/40/80

2

SEP/PX/40/80/TR

3

SEP/SAN/40/80



40x80 cm
15.7x31.4 in



4 Kg
8.8 £

4,5 cm
1.8 in

SEP/PX/40/100

SEP/PX/40/100/TR

SEP/SAN/40/100

40x100 cm
15.7x39.3 in

4,5 Kg
9.9 £

SEP/PX/40/120

SEP/PX/40/120/TR

SEP/SAN/40/120

40x120 cm
15.7x47.2 in

5 Kg
11 £

SEP/PX/40/140

SEP/PX/40/140/TR

SEP/SAN/40/140

40x140 cm
15.7x55.1 in

5,5 Kg
12 £

SEP/PX/40/160

SEP/PX/40/160/TR

SEP/SAN/40/160

40x160 cm
15.7x62.9 in

6 Kg
13.2 £

SEP/PX/40/180

SEP/PX/40/180/TR

SEP/SAN/40/180

40x180 cm
15.7x70.8 in

6,5 Kg
14.3 £

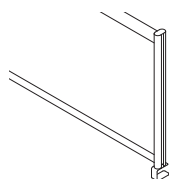

1

SEP/PX/60/80

2

SEP/PX/60/80/TR

3

SEP/SAN/60/80



60x80 cm
23.6x31.4 in



6 Kg
13.2 £

SEP/PX/60/100

SEP/PX/60/100/TR

SEP/SAN/60/100

60x100 cm
23.6x39.3 in

6,5 Kg
14.3 £

SEP/PX/60/120

SEP/PX/60/120/TR

SEP/SAN/60/120

60x120 cm
23.6x47.2 in

7 Kg
15.4 £

SEP/PX/60/140

SEP/PX/60/140/TR

SEP/SAN/60/140

60x140 cm
23.6x55.1 in

7,5 Kg
16.5 £

SEP/PX/60/160

SEP/PX/60/160/TR

SEP/SAN/60/160

60x160 cm
23.6x62.9 in

8 Kg
17.6 £

SEP/PX/60/180

SEP/PX/60/180/TR

SEP/SAN/60/180

60x180 cm
23.6x70.8 in

8,5Kg
18.7 £

Glass Screen + Clamps



Mobile screen made from 6 mm clear laminated glass. (3 + 3 mm. Approved), Fixing to the tabletop using clamps that allow the thickness of the table to be adjusted. Ideal for placing on front counters at shops and business premises facing the public, as well as in offices to separate and give safety to staff. Various sizes available and option of with or without window. Clean with a dry cloth and neutral detergent. Clamps available.

Mampara móvil fabricada en cristal laminado incoloro de 6 mm. (3+3 mm. homologado), Fijación al sobre de la mesa mediante pinzas que permiten graduar el grosor de la mesa. Ideal para ubicar en los mostradores de tiendas y establecimientos cara al público, así como en oficinas para separar y dar seguridad a las personas que las habitan. Disponibles varias medidas y opción de con o sin ventanilla. Limpiar con paño seco y detergente neutro. Pinzas disponibles sueltas.

Cloison mobile en verre feuilleté incolore de 6 mm. (3 + 3 mm. Homologué), Fixation au plateau à l'aide de pinces permettant d'ajuster l'épaisseur de la table. Idéal pour les guichets, les établissements publics, ainsi que les bureaux pour séparer et sécuriser les personnes qui les côtoient. Différentes tailles disponibles, avec ou sans fenêtre. Nettoyer avec un chiffon sec et un détergent neutre. Pincas disponibles.

Sizes

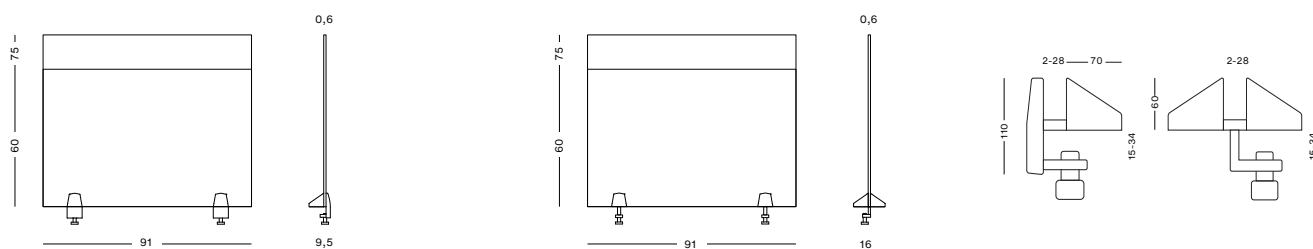

Options



COMPLET

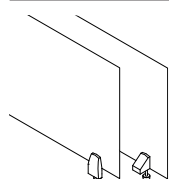

END TABLE
EP/MPS1/60/91
EP/MPS1/75/91

INTERMEDIATE TABLE
EP/MPS2/60/91
EP/MPS2/75/91

↕ ↔
60x91 cm
23.6x35.8 in
75x91 cm
29.5x35.8 in

📦
9 Kg
19.8 £
9,5 Kg
21 £



0,6 cm
0.2 in

ONLY CLAMP



END TABLE
EP/PZ/1

↕
1,5 to 3,4 cm
0.5 to 1.3 in

📦
0,2 Kg
0.4 £



2 to 2,8 cm
0.78 to 1.1 in



INTERMEDIATE TABLE
EP/PZ/2

↕
1,5 to 3,5 cm
0.5 to 1.4 in

📦
0,2 Kg
0.4 £



Ten Limit Acrylic Screen



Ten Limit partition made from polycarbonate with various finishes and transparency. Anodized aluminum profile frame available in matt silver, or anthracite and white lacquered and feet with castors made of cast aluminum. Ideal for separating work environments, coworking and offices, as well as defining collaborative or training spaces to offer safety to attendees.

Mampara separadora Ten Limit fabricada en policarbonato de diversos acabados y transparencia. Marco de perfil de aluminio anodizado disponible en plata mate, o lacado antracita y blanco y pies con ruedas fabricados de fundición de aluminio. Ideal para separar ambientes de trabajo, en coworkings y oficinas, así como delimitar espacios colaborativos o de formación para ofrecer seguridad a los asistentes.

Cloison Ten Limit en polycarbonate avec différentes finitions et transparence. Cadre en profilé d'aluminium anodisé disponible en argent mat ou laqué anthracite et blanc et pieds avec roues en fonte d'aluminium. Idéal pour séparer les environnements de travail, les coworkings et les bureaux, ainsi que pour définir des espaces collaboratifs ou de formation pour offrir une sécurité aux participants.



Ten Limit Acrylic Screen

Sizes

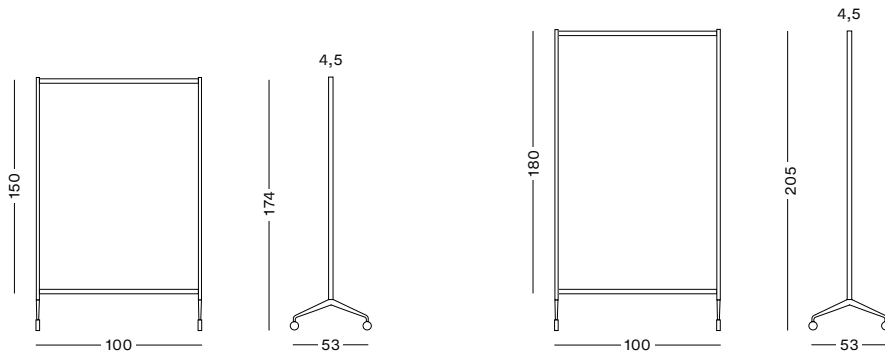

Aluminium frame



Specs



Options

RIBBED TRANSLUCENT

RIBBED SEMI TRANSPARENT

TRANSPARENT 100%



1



2

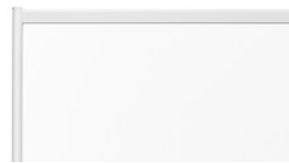

3

SUPPORT



SILVER FRAME



SUPPORT



1

TL/150/PX

TL/180/PX

2

TL/150/TR

TL/180/TR

3

TL/150/SAN

TL/180/SAN



150x100 cm
59,05x39,3 in

180x100 cm
70,8x39,3 in



174 cm
68.5 in

205 cm
80.7 in



8 Kg
17.6 £

9 Kg
19.8 £

4,5 cm
1.7 in

53 cm
20.8 in

SUPPORT



ANTHRACITE FRAME



SUPPORT



1

TL/150/PX/AN

TL/180/PX/AN

2

TL/150/TR/AN

TL/180/TR/AN

3

TL/150/SAN/AN

TL/180/SAN/AN



150x100 cm
59,05x39,3 in

180x100 cm
70,8x39,3 in



174 cm
68.5 in

205 cm
80.7 in



8 Kg
17.6 £

9 Kg
19.8 £

4,5 cm
1.7 in

53 cm
20.8 in

SUPPORT



WHITE FRAME



SUPPORT



1

TL/150/PX/BL

TL/180/PX/BL

2

TL/150/TR/BL

TL/180/TR/BL

3

TL/150/SAN/BL

TL/180/SAN/BL



150x100 cm
59,05x39,3 in

180x100 cm
70,8x39,3 in



174 cm
68.5 in

205 cm
80.7 in



8 Kg
17.6 £

9 Kg
19.8 £

4,5 cm
1.7 in

53 cm
20.8 in

Antibacterial Ten Limit Screen



Ten Limit partition made from easy-to-clean antibacterial melamine. Anodized aluminum profile frame available in matt silver, or anthracite and white lacquered and feet with castors made of cast aluminum. Ideal for separating work environments, coworking and offices, as well as defining collaborative or training spaces to offer safety to attendees. Available in 3 colours.

Mampara separadora Ten Limit fabricada en melamina antibacteriana fácil de limpiar. Marco de perfil de aluminio anodizado disponible en plata mate, o lacado antracita y blanco, y pies con ruedas fabricados de fundición de aluminio. Ideal para separar ambientes de trabajo, en coworkings y oficinas, así como delimitar espacios colaborativos o de formación para ofrecer seguridad a los asistentes. Disponible en 3 colores.

Cloison Ten Limit en mélamine antibactérienne facile à nettoyer. Cadre en profilé d'aluminium anodisé disponible en argent mat ou laqué anthracite et blanc et pieds avec roues en fonte d'aluminium. Idéal pour séparer les environnements de travail, les coworkings et les bureaux, ainsi que pour définir des espaces collaboratifs ou de formation pour offrir une sécurité aux participants. Disponible en 3 couleurs.



Antibacterial Ten Limit Screen

Sizes

Aluminium frame

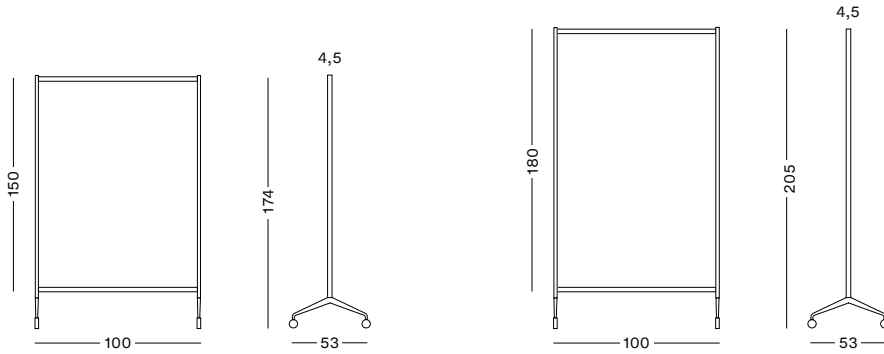

Specs



Options

ANTIBACTERIAL GREY

ANTIBACTERIAL GRAPHITE

ANTIBACTERIAL WHITE

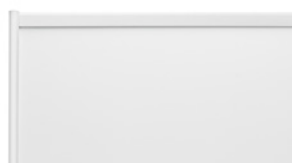
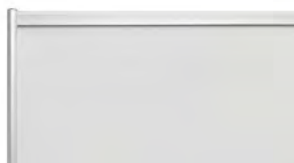

SUPPORT

 SILVER FRAME

→ ← → ← SUPPORT

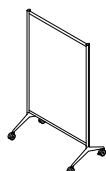

TL/150/AB/GR



TL/150/AB/GG



TL/150/AB/BL



150x100 cm
59,05x39,3 in



174 cm
68.5 in



10 Kg
22 £

4,5 cm
1.7 in

53 cm
20.8 in

TL/180/AB/GR

TL/180/AB/GG

TL/180/AB/BL

180x100 cm
70,8x39,3 in

205 cm
80.7 in

12 Kg
26.4 £

SUPPORT

 ANTHRACITE FRAME

→ ← → ← SUPPORT

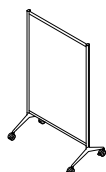

TL/150/AB/AN/GR



TL/150/AB/AN/GG



TL/150/AB/AN/BL



150x100 cm
59,05x39,3 in



174 cm
68.5 in



10 Kg
22 £

4,5 cm
1.7 in

53 cm
20.8 in

TL/180/AB/AN/GR

TL/180/AB/AN/GG

TL/180/AB/AN/BL

180x100 cm
70,8x39,3 in

205 cm
80.7 in

12 Kg
26.4 £

SUPPORT

 WHITE FRAME

→ ← → ← SUPPORT



TL/150/AB/BL/GR



TL/150/AB/BL/GG



TL/150/AB/BL/BL



150x100 cm
59,05x39,3 in



174 cm
68.5 in



10 Kg
22 £

4,5 cm
1.7 in

53 cm
20.8 in

TL/180/AB/BL/GR

TL/180/AB/BL/GG

TL/180/AB/BL/BL

180x100 cm
70,8x39,3 in

205 cm
80.7 in

12 Kg
26.4 £

Limit Acrylic Screen



Limit partition wall made from polycarbonate with various finishes and transparency. Anodized aluminum profile frame available in matt silver, or anthracite and white lacquered and matching metal trapezoidal feet. Ideal for separating work environments, coworking and offices, as well as defining collaborative or training spaces to offer safety to attendees.

Mampara separadora Limit fabricada en policarbonato de diversos acabados y transparencia. Marco de perfil de aluminio anodizado disponible en plata mate, o lacado antracita y blanco, y pies trapezoidales metálicos a juego. Ideal para separar ambientes de trabajo, en coworkings y oficinas, así como delimitar espacios colaborativos o de formación para ofrecer seguridad a los asistentes.

Cloison de séparation en polycarbonate avec différentes finitions et transparence. Structure profilée en aluminium anodisé disponible en argent mat ou laqué anthracite et blanc et pieds trapézoïdaux en métal assortis. Idéal pour séparer les environnements de travail, les coworkings et les bureaux, ainsi que pour définir des espaces collaboratifs ou de formation pour offrir une sécurité aux participants.



Limit Acrylic Screen

Sizes

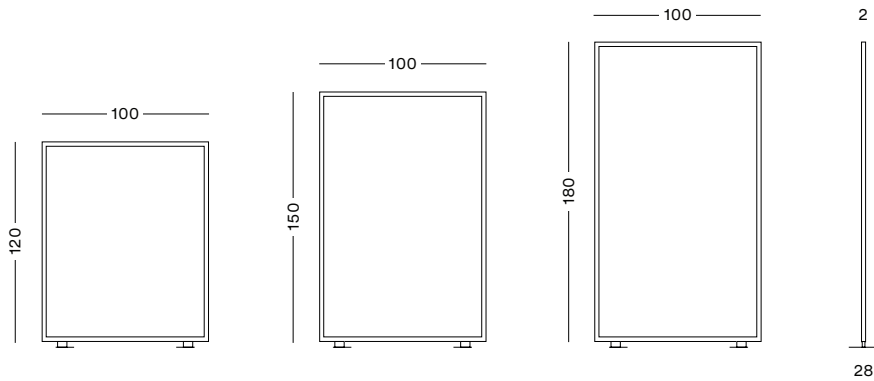

Specs



Aluminium frame

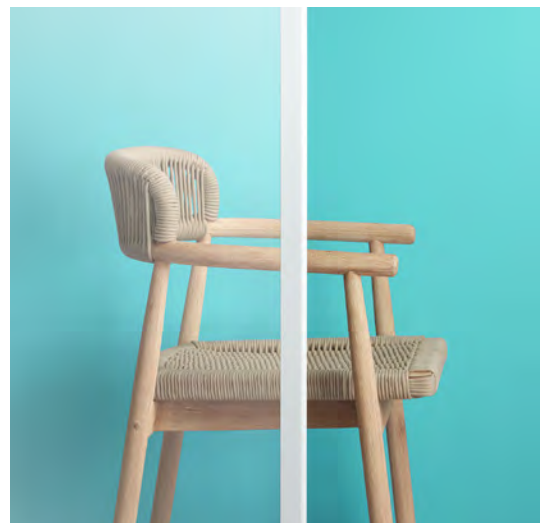
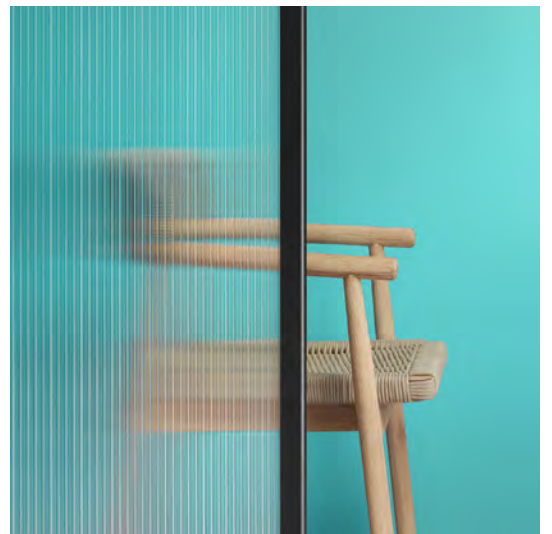

Options

RIBBED TRANSLUCENT

RIBBED SEMI TRANSPARENT

TRANSPARENT 100%



1



2



3

SUPPORT



SILVER FRAME



SUPPORT

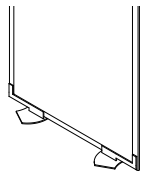

1

300/1/PX

2

300/1/TR

3

300/1/SAN



120x100 cm
47.2x39.3 in



122 cm
48 in



7 kg
15.4 lb

2 cm
0.7 in

28 cm
11 in

300/2/PX

300/2/TR

300/2/SAN

150x100 cm
59.05x39.3 in

152 cm
59.8 in

8 kg
17.6 lb

300/3/PX

300/3/TR

300/3/SAN

180x100 cm
70.8x39.3 in

182 cm
71.6 in

9 kg
19.8 lb

SUPPORT



ANTHRACITE FRAME



SUPPORT

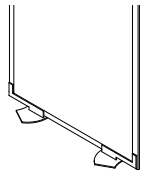

1

300/1/AN/PX

2

300/1/AN/TR

3

300/1/AN/SAN



120x100 cm
47.2x39.3 in



122 cm
48 in



7 kg
15.4 lb

2 cm
0.7 in

28 cm
11 in

300/2/AN/PX

300/2/AN/TR

300/2/AN/SAN

150x100 cm
59.05x39.3 in

152 cm
59.8 in

8 kg
17.6 lb

300/3/AN/PX

300/3/AN/TR

300/3/AN/SAN

180x100 cm
70.8x39.3 in

182 cm
71.6 in

9 kg
19.8 lb

SUPPORT



WHITE FRAME



SUPPORT

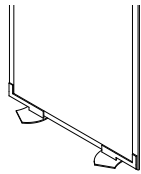

1

300/1/BL/PX

2

300/1/BL/TR

3

300/1/BL/SAN



120x100 cm
47.2x39.3 in



122 cm
48 in



7 kg
15.4 lb

2 cm
0.7 in

28 cm
11 in

300/2/BL/PX

300/2/BL/TR

300/2/BL/SAN

150x100 cm
59.05x39.3 in

152 cm
59.8 in

8 kg
17.6 lb

300/3/BL/PX

300/3/BL/TR

300/3/BL/SAN

180x100 cm
70.8x39.3 in

182 cm
71.6 in

9 kg
19.8 lb

Antibacterial Limit Screen



Limit partition made from easy-to-clean antibacterial melamine. Anodized aluminum profile frame available in matt silver, or anthracite and white lacquered and matching metal trapezoidal feet. Ideal for separating work environments, coworking and offices, as well as defining collaborative or training spaces to offer safety to attendees. Available in 3 colours.

Mampara separadora Limit fabricada en melamina antibacteriana fácil de limpiar. Marco de perfil de aluminio anodizado disponible en plata mate, o lacado antracita y blanco, y pies trapezoidales metálicos a juego. Ideal para separar ambientes de trabajo, en coworkings y oficinas, así como delimitar espacios colaborativos o de formación para ofrecer seguridad a los asistentes. Disponible en 3 colores.

Cloison Limit en mélamine antibactérienne facile à nettoyer. Structure de profilé en aluminium anodisé disponible en argent mat ou laqué anthracite et blanc et pieds trapézoïdaux en métal assortis. Idéal pour séparer les environnements de travail, les coworkings et les bureaux, ainsi que pour définir des espaces collaboratifs ou de formation pour offrir une sécurité aux participants. Disponible en 3 couleurs.



Antibacterial Limit Screen

Sizes

Aluminium frame

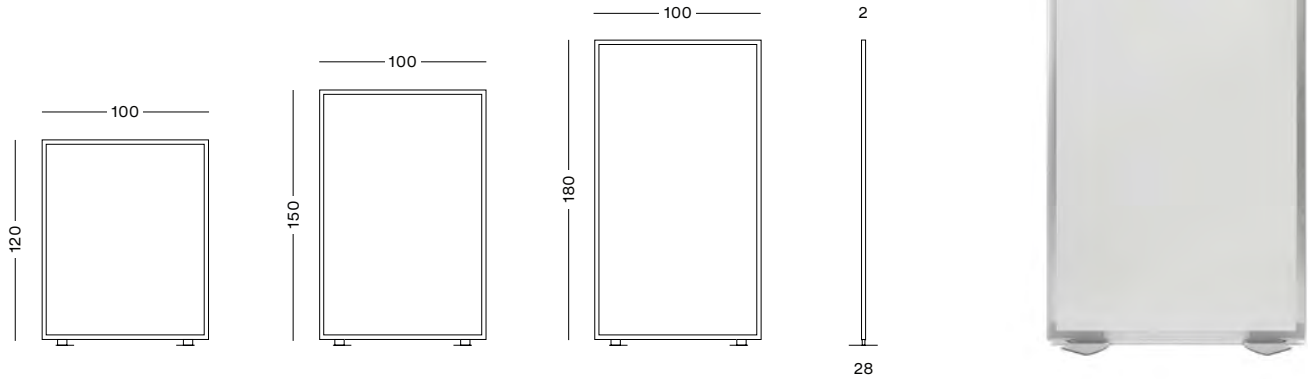

Specs



Options

ANTIBACTERIAL GREY



ANTIBACTERIAL GRAPHITE



ANTIBACTERIAL WHITE



SUPPORT

 SILVER FRAME

→ ← → ← SUPPORT

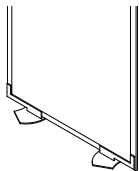

●	●	○	↕ ↔	↕	⚖		
300/1/AB/GR	300/1/AB/GG	300/1/AB/BL	120x100 cm 47.2x39.3 in	122 cm 48 in	10 kg 22 £	2 cm 0.7 in	28 cm 11 in
300/2/AB/GR	300/2/AB/GG	300/2/AB/BL	150x100 cm 59.05x39.3 in	152 cm 59.8 in	11 kg 24.2 £		
300/3/AB/GR	300/3/AB/GG	300/3/AB/BL	180x100 cm 70.8x39.3 in	182 cm 71.6 in	12 kg 26.4 £		

SUPPORT

 ANTHRACITE FRAME

→ ← → ← SUPPORT

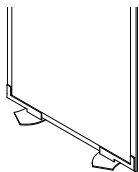

●	●	○	↕ ↔	↕	⚖		
300/1/AB/GR	300/1/AB/GG	300/1/AB/BL	120x100 cm 47.2x39.3 in	122 cm 48 in	10 kg 22 £	2 cm 0.7 in	28 cm 11 in
300/2/AB/GR	300/2/AB/GG	300/2/AB/BL	150x100 cm 59.05x39.3 in	152 cm 59.8 in	11 kg 24.2 £		
300/3/AB/GR	300/3/AB/GG	300/3/AB/BL	180x100 cm 70.8x39.3 in	182 cm 71.6 in	12 kg 26.4 £		

SUPPORT

 WHITE FRAME

→ ← → ← SUPPORT

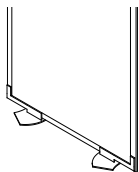

●	●	○	↕ ↔	↕	⚖		
300/1/AB/GR	300/1/AB/GG	300/1/AB/BL	120x100 cm 47.2x39.3 in	122 cm 48 in	10 kg 22 £	2 cm 0.7 in	28 cm 11 in
300/2/AB/GR	300/2/AB/GG	300/2/AB/BL	150x100 cm 59.05x39.3 in	152 cm 59.8 in	11 kg 24.2 £		
300/3/AB/GR	300/3/AB/GG	300/3/AB/BL	180x100 cm 70.8x39.3 in	182 cm 71.6 in	12 kg 26.4 £		

Gel Dispensers



Range of self-supporting dispensers for Gel and / or disposable gloves and tissues made of white epoxy painted metal. Included 1 liter refillable hydroalcoholic gel bottle equipped with an anti-theft system. The / PAP model incorporates a 40-liter bin. Clean with a damp cloth and a neutral detergent type window cleaner. clean with a dry cloth.

Gama de dispensadores autoportantes de Gel y/o guantes y pañuelos desechables fabricados en metal pintados epoxi en color blanco. Botella de gel hidroalcohólico rellenable incluida de 1 litro dotada de sistema antirrobo. El modelo /PAP incorpora una papelera de 40 litros. Limpiar con un paño húmedo y detergente neutro tipo limpiacristales. Secar con un paño seco.

Gamme de distributeurs autoportants pour gel et/ou gants (ou mouchoirs), en métal peint époxy blanc. Flacon de gel hydroalcoolique rechargeable de 1 litre inclus avec un système antivol. Le modèle / PAP intègre un bac de 40 litres. Nettoyer avec un chiffon humide et un nettoyant pour vitres de type détergent neutre. Sécher avec un chiffon sec.



Gel Dispensers

EP/DGM



EP/DGG



Size

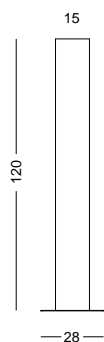

Size

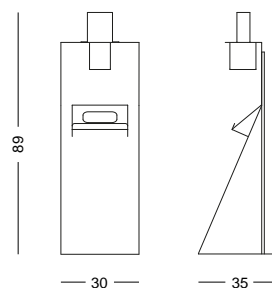

Data

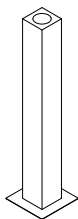

Data

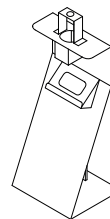

REF	↕ ↔	↗ ↘	👤
EP/DGM	120x28 cm 47.2x11 in	28 cm 11 in	10 Kg 22 £

REF	↕ ↔	↗ ↘	👤
EP/DGG	89x30 cm 35x11.8 in	35 cm 13.7 in	6 Kg 13.2 £

*
Bottle with gel included (1L)
Botella con gel incluido (1L)
Bouteille avec gel inclus (1L)

*
Bottle with gel included (1L)
Botella con gel incluido (1L)
Bouteille avec gel inclus (1L)

EP/GG/PAP



Size

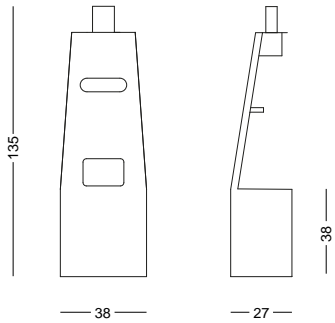

Data

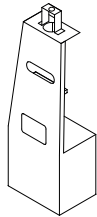

REF	↕ ↔	→ ←	👤
EP/DGG/PAP	135x38 cm 53.1x14.9 in	27 cm 10.6 in	11 Kg 24.2 £

*
Bottle with gel included (1L)
Botella con gel incluido (1L)
Bouteille avec gel inclus (1L)



Automatic Gel Dispensers



Range of self-supporting gel dispensers made from white epoxy painted metal. Automatic or pedal-operated, they are ideal for placing at entrances to establishments, offices, etc ... The XL version includes a 5-liter bottle of gel and is ideal for places with a large influx of people. Clean with a damp cloth and a neutral detergent type window cleaner. Dry with a dry cloth.

Gama de dispensadores de gel autoportantes fabricados en metal pintados epoxi en color blanco. Accionamiento automático o a pedal, son ideales para ubicar en entradas de establecimientos, oficinas, etc... La versión XL incluye bidón de 5 litros de gel y es ideal para lugares de gran afluencia de público. Limpiar con un paño húmedo y detergente neutro tipo limpiacristales. Secar con un paño seco.

Gamme de distributeurs de gel autoportants en métal peint époxy blanc. Automatiques ou à pédales, ils sont idéaux pour être placés à l'entrée d'établissements publics, bureaux, etc ... La version XL comprend une bouteille de gel de 5 litres et est idéale pour les lieux à fort afflux de personnes. Nettoyer avec un chiffon humide et un nettoyant pour vitres de type détergent neutre. Sécher avec un chiffon sec.

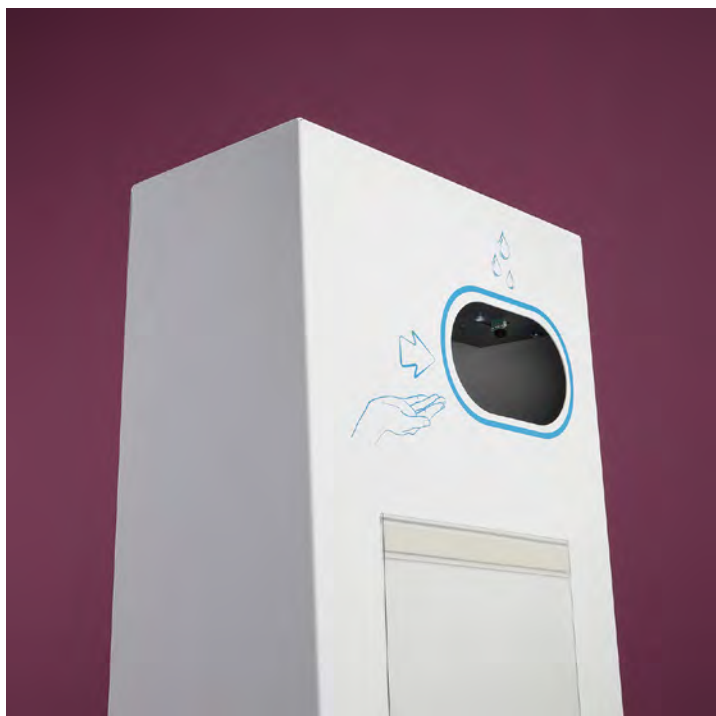

Automatic Gel Dispensers

EP/DGP



Size



Data

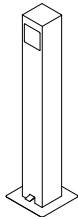

REF	↕ ↔	↗ ↘	👤
EP/DGP	120x28 cm 47.2x11 in	28 cm 11 in	11 Kg 24.2 £

*
Bottle with gel included (1L)
Botella con gel incluido (1L)
Bouteille avec gel inclus (1L)

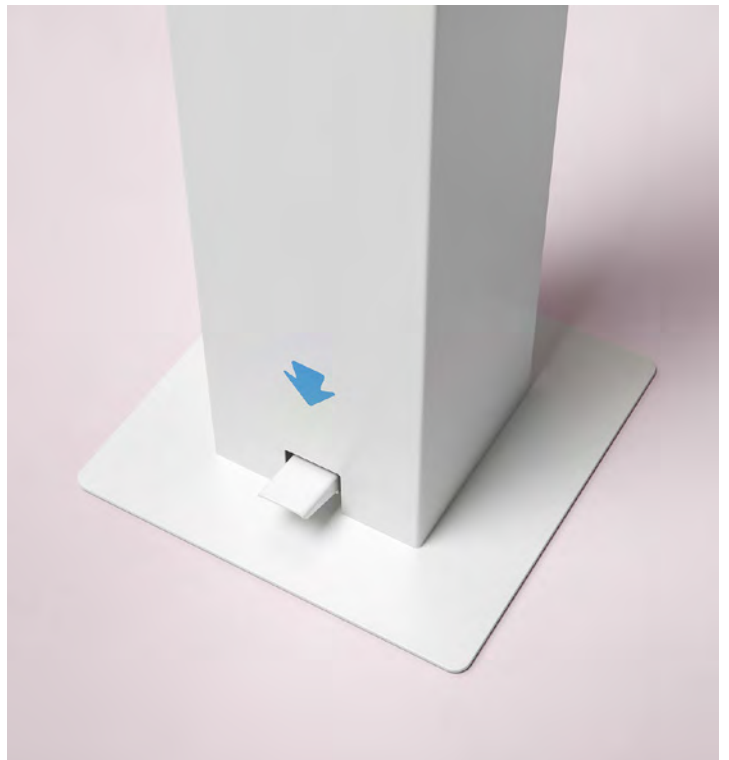

EP/DGA



EP/DGA/XL



Size

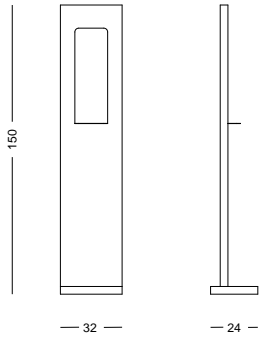

Size

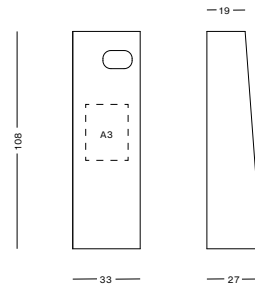

Data

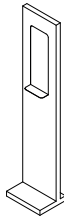

Data

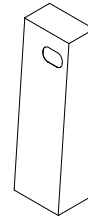

REF	↕ ↔	↗ ↘	⚖
EP/DGA	150x32 cm 59x12.5 in	24 cm 9.4 in	12 Kg 26.2 £

REF	↕ ↔	↗ ↘	⚖
EP/DGA/XL	108x33 cm 42.5x13 in	27 cm 10.6 in	20 Kg 44 £

*
Gel not included / Gel dispenser capacity (1L)
Gel no incluido / Capacidad dispensador gel (1L)
Gel non inclus / Capacité du distributeur gel (1L)

*
Bottle with gel included (5L) / Acrilic support A3 included
Botella con gel incluido (5L) / Soporte acrilico A3 incluido
Bouteille avec gel inclus (5L) / Support acrilique A3 inclus

Outdoor Gel Dispensers



Range of mobile self-supporting gel dispensers made from matt silver anodized aluminum. Available in a version with support for glove box or disposable tissues and / or bin holder ring, they are ideal for placing at entrances to public establishments, offices, cinemas, shopping centers, etc ... Clean with a damp cloth and a neutral detergent type window cleaner. Dry with a dry cloth.

Gama de dispensadores de gel autoportantes móviles fabricados en aluminio anodizado plata mate. Disponibles en versión con soporte para caja de guantes o pañuelos desechables y/o aro porta papelera, son ideales para ubicar en entradas de establecimientos, oficinas, cines, centros comerciales, etc... Limpiar con un paño húmedo y detergente neutro tipo limpiacristales. Secar con un paño seco.

Gamme de distributeurs de gel auto-portants mobiles en aluminium anodisé argent mat. Disponibles en version avec support pour boîte à gants ou mouchoirs jetables et / ou anneau porte-poubelle. Ils sont idéaux pour être placés à l'entrée d'établissements publics, bureaux, cinémas, centres commerciaux, etc... Nettoyer avec un chiffon humide et une vitre de type détergent neutre nettoyeur. Sécher avec un chiffon sec.



Outdoor Gel Dispensers

EP/SOP/IGP



EP/SOP/IGG



Size

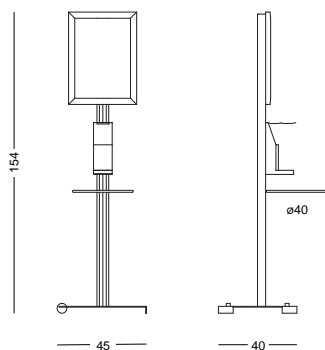

Size

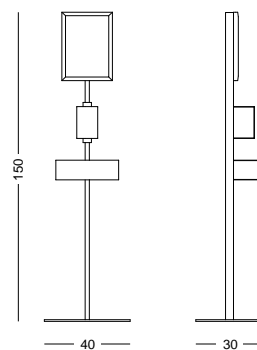

Data

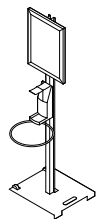

Data

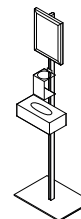

REF	↕ ↔	↗ ↘	⚖
EP/SOP/IGP	154x45 cm 60.6x17.7 in	40 cm 15.7 in	13 Kg 28.6 £

REF	↕ ↔	↗ ↘	⚖
EP/SOP/IGG	150x40 cm 59x15.7 in	30 cm 11.8 in	10 Kg 22 £

*
Bottle included (1L) / Gel not included
Botella incluida (1L) / Gel no incluido
Bouteille inclus (1L) / Gel non inclus

*
Bottle with gel not included
Botella con gel no incluido
Bouteille avec gel non inclus

EP/SOP/IGP + EP/SOP/IGG + EP/SOP/DG

EP/SOP/DG



Size

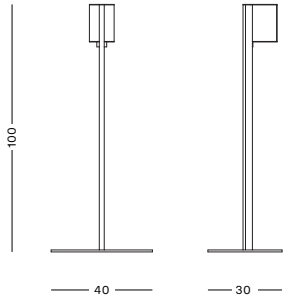

Data

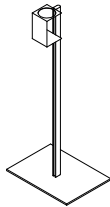

REF	↕ ↔	↗ ↖	👤
EP/SOP/DG	100x40 cm 39.3x15.7 in	30 cm 11.8 in	7 kg 15.4 lb

*
Bottle with gel not included
Botella con gel no incluido
Bouteille avec gel non inclus

EP/SOP/M



Size

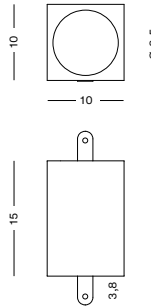

Data

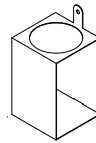

①

REF	↕ ↔	↗ ↖	👤
① EP/SOP/M	15x10 cm 5.9x 3.9 in	10 cm 3.9 in	0,7 kg 1.5 lb

*
Bottle with gel and gloves not included
Botella de gel y guantes no incluida
Bouteille avec gel et gants non inclus

EP/SOP/GM

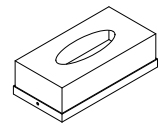
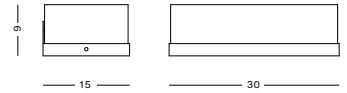

②

REF	↕ ↔	↗ ↖	👤
② EP/SOP/GM	9x30 cm 3.5x11.8 in	15 cm 5.9 in	1,4 kg 3 lb

Acces Control



Freestanding or desktop totem painted in black, capacity control information panel with remote control LED lighting technology, ideal for places and spaces with high concentration and influx of people such as shopping centers, hotels, cinemas, etc ... Available in different languages. Includes remote control.

Tótem autoportante o de sobremesa pintado en color negro, panel informativo de control de aforo con tecnología iluminación LED con control remoto, ideal para lugares y espacios de gran concentración y afluencia de personas como centros comerciales, hoteles, cines, etc... Disponible en distintos idiomas. Incluye mando a distancia.

Totem auto-portant ou à poser sur une table, peint en noir avec un panneau d'information de contrôle de la capacité d'accueil avec technologie d'éclairage LED et télécommande. Idéal pour les lieux et espaces à forte concentration et afflux de personnes tels que les centres commerciaux, les hôtels, les cinémas, etc. Disponible en différentes langues. Comprend une télécommande.

Sizes

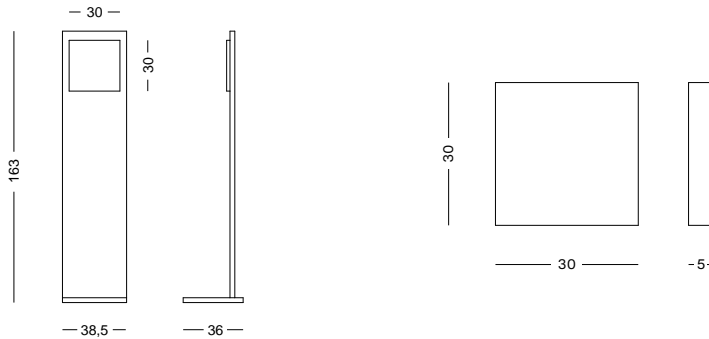

Options



REF	↕ ↔	↗ ↖	👤
EP/TCA/ES	163x38,5 cm 64.1x15.1 in	36 cm 14.1 in	13 Kg 28.6 £
EP/TCA/CAT	163x38,5 cm 64.1x15.1 in		
EP/TCA/EN	163x38,5 cm 64.1x15.1 in		
EP/TCA/FR	163x38,5 cm 64.1x15.1 in		

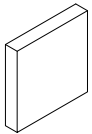

REF	↕ ↔	↗ ↖	👤
EP/SCA/ES	30x30 cm 11.8x11.8 in	5 cm 1.9 in	3,5 Kg 7.7 £
EP/SCA/CAT	30x30 cm 11.8x11.8 in		
EP/SCA/EN	30x30 cm 11.8x11.8 in		
EP/SCA/FR	30x30 cm 11.8x11.8 in		

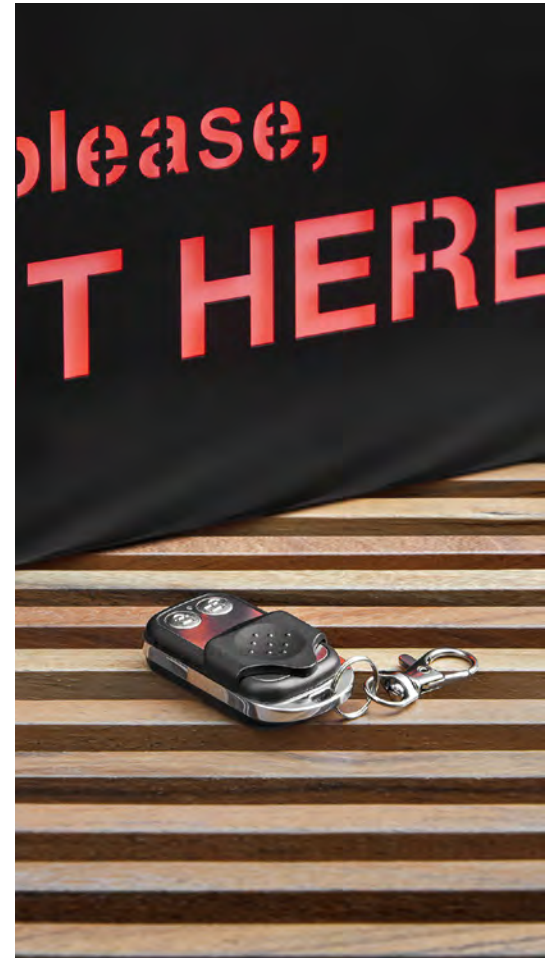

Contract

Ten Limit Acrylic Screen	220
Limit Acrylic Screen	222
Basic Wastepaper	224
Self-Extinguishing Bin	226
Swing Bin	228
Cubic Bin	230
Pedal Bin	232
Recycling Container / Bin	234
Metallic Bin	236
Inox Pedal Bin	238
Plastic Pedal Bin	240
Plastic Pedal Container	242
Outdoor Ashtray	244
Coat Stand	248
Wall Coat Rack	250
Eco 2 Coat Stand	252
Eco 4 Coat Stand	256
Rack Coat Stand	260
Display Showcase	262
Sign System	266

Sometimes we don't realize the importance of accessories, they are not essential or necessary. At Planning Sisplamo we believe that accessories are not only necessary but essential, functional and aesthetic. Enough already! of accessories hidden or relegated in places with little traffic. The accessory revolution has arrived, elements that beyond their functionality manage to harmonize the places for which they have been created.

En ocasiones usamos como accesorio a todo aquello que sobra, que no es primordial o necesario. Nosotros hemos decidido que nuestros accesorios sean no tan solo necesarios sino esenciales, funcionales y estéticos. Basta ya! de accesorios escondidos o relegados en lugares poco transitados. La revolución del accesorio ha llegado, elementos que más allá de su funcionalidad consiguen armonizar los espacios para los que han sido creados.

Parfois, nous utilisons comme accessoire tout ce qui reste, ce qui n'est ni essentiel ni nécessaire. Nous avons décidé que nos accessoires sont non seulement nécessaires mais aussi essentiels, fonctionnels et esthétiques. Assez! des accessoires cachés ou relégués dans des endroits peu fréquentés. La révolution des accessoires est arrivée, des éléments qui au-delà de leur fonctionnalité parviennent à harmoniser les espaces pour lesquels ils ont été créés.





Ten Limit Screen



Ten Limit division screens available in 4 finishes (slate, polycarbonate, melamine antibacterial or acoustic PET). Anodized aluminum profile frame available in matt silver, or anthracite and white lacquered and feet with castors made of cast aluminum. Ideal for separating work environments, coworking and offices, as well as defining collaborative or training spaces to offer safety to attendees.

Colección de mamparas separadoras Ten Limit disponibles en 4 acabados (pizarra, policarbonato, melamina antibacteriano o PET acústico). Marco de perfil de aluminio anodizado disponible en plata mate, o lacado antracita y blanco; pies con ruedas fabricados de fundición de aluminio. Ideal para separar ambientes de trabajo, en coworkings y oficinas, así como delimitar espacios colaborativos o de formación para ofrecer seguridad a los asistentes.

Collection de cloisons séparatrices Ten Limit disponibles en 4 finitions (Tableau, polycarbonate, mélamine antibactérienne ou PET acoustique). Cadre en profilé d'aluminium anodisé disponible en argent mat ou laqué anthracite et blanc et pieds avec roues en fonte d'aluminium. Idéal pour séparer les environnements de travail, les coworkings et les bureaux, ainsi que pour définir des espaces collaboratifs ou de formation pour offrir une sécurité aux participants.

Choose your option

Acrylic Panel

→ VIEW ON PAGE: 186

Acoustic Panel

→ VIEW ON PAGE: 152

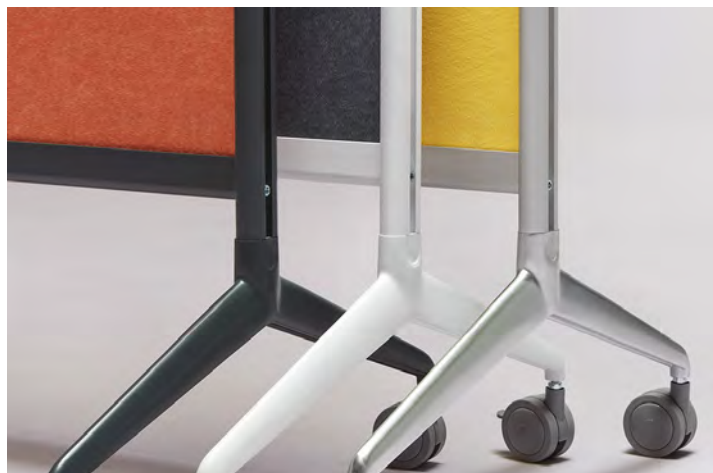

Antibacterial Panel

→ VIEW ON PAGE: 190

Writeboard Panel

→ VIEW ON PAGE: 84

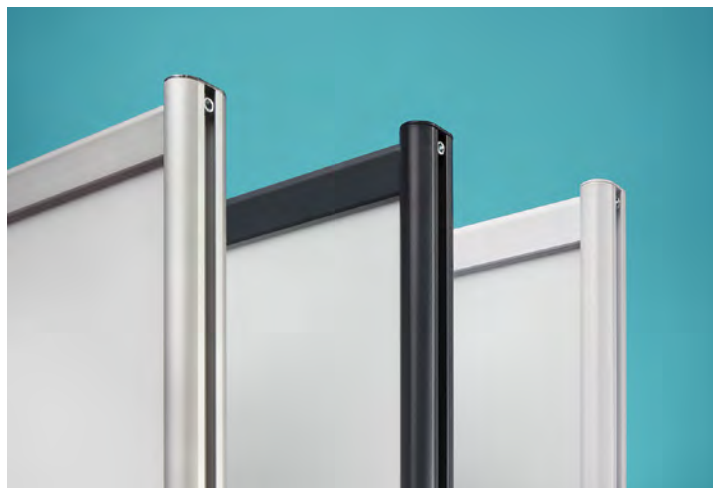

Limit Screen



Limit division screens available in 4 finishes (slate, polycarbonate, melamine antibacterial or acoustic PET). Anodized aluminum profile frame available in matt silver, or anthracite and white lacquered and matching metal trapezoidal feet. Ideal for separating work environments, coworking and offices, as well as defining collaborative or training spaces to offer safety to attendees.

Colección de mamparas separadoras Limit disponibles en 4 acabados (pizarra, policarbonato, melamina antibacteriano o PET acústico). Marco de perfil de aluminio anodizado disponible en plata mate, o lacado antracita y blanco; pies trapezoidales metálicos a juego. Ideal para separar ambientes de trabajo, en co-working y oficinas, así como delimitar espacios colaborativos o de formación para ofrecer seguridad a los asistentes.

Collection de cloisons séparatrices Limit disponibles en 4 finitions (Tableau, polycarbonate, mélamine anti-bactérienne ou PET acoustique). Structure profilée en aluminium anodisé disponible en argent mat ou laqué anthracite et blanc et pieds trapézoïdaux en métal assortis. Idéal pour séparer les environnements de travail, les coworkings et les bureaux, ainsi que pour définir des espaces collaboratifs ou de formation pour offrir une sécurité aux participants.

Choose your option

Acrylic Panel

→ VIEW ON PAGE: 194

Acoustic Panel

→ VIEW ON PAGE: 148

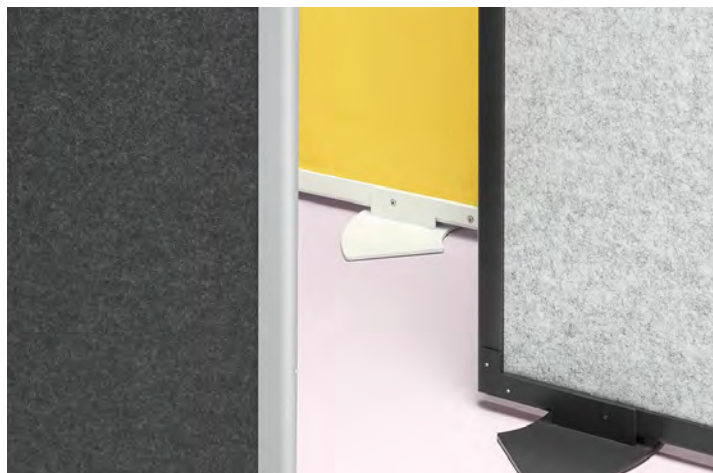

Antibacterial Panel

→ VIEW ON PAGE: 198

Writeboard Panel

→ VIEW ON PAGE: 80

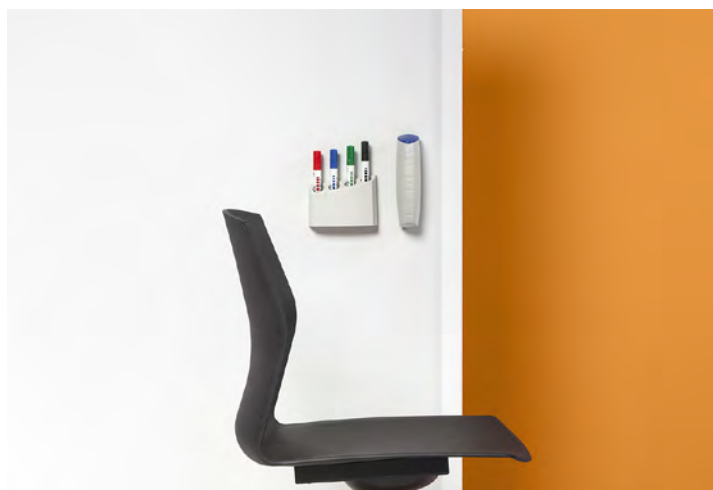

Basic Waste Bins



Range of smooth metal waste bins painted epoxy, provided with a non-slip PVC bottom ring. Available in 12, 16 and 27 liters and in white, black or grey. Ideal for office workstations, countertops, or home use.

Gama de papeleras metálicas lisas pintadas epoxy, provistas de aro inferior de PVC antideslizante. Disponibles en 12, 16 y 27 litros, en color blanco, negro o gris. Ideal para puestos de trabajo en oficinas, mostradores o uso doméstico.

Gamme de corbeilles métalliques peintes avec de la peinture époxy, munies d'un anneau inférieur en PVC antidérapant. Disponible en 12, 16 et 27 litres, en blanc, noir ou gris. Idéal pour les postes de travail de bureau, les comptoirs ou la maison.

Sizes

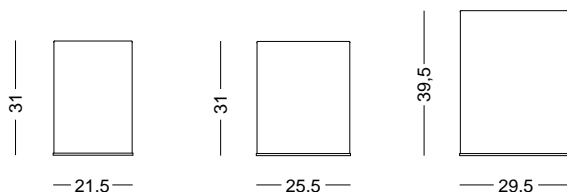

Options



Colours



	●	●	○	↕	∅	⚖	💧
6001/PL	6001/NG	6001/BL	31 cm 12.2 in	21,5 cm 8.4 in	1,1 Kg 2.4 £	12 L 3.1 gal	
6002/PL	6002/NG	6002/BL	31 cm 12.2 in	25,5 cm 10 in	1,3 Kg 2.8 £	16 L 4.2 gal	
6003/PL	6003/NG	6003/BL	39,5 cm 64.1 in	29,5 cm 11.6 in	2,3 Kg 5 £	27 L 7.1 gal	



Self-Extinguishing Bins



Smooth, fire-retardant metal waste bin painted in epoxy, provided with a non-slip PVC bottom ring. Due to the shape of the head, the possible fire generated inside is quickly self-extinguished. Available standard in grey. Ideal for office workstations, countertops, or home use.

Papelera metálica lisa ignífuga pintada en epoxy, provista de aro inferior de PVC antideslizante. Por la forma del cabezal, el posible fuego generado en el interior se auto extingue rápidamente. Disponible standard en color gris. Ideal para puestos de trabajo en oficinas, mostradores o uso doméstico.

Corbeille métallique, ignifuge peinte avec de la peinture époxy, munie d'un anneau inférieur en PVC antidérapant. Grâce à la forme de son couvercle, l'incendie généré à l'intérieur est rapidement auto-éteint. Disponible en gris. Idéal pour les postes de travail, de bureau ou la maison.

Sizes

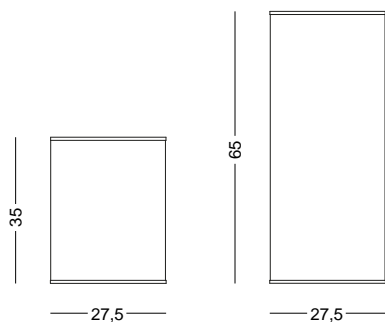

Specs



Colours



/GR

Options



REF	Height	Ø	Weight	Capacity
6022/GR	35 cm 13.7 in	27,5 cm 10.8 in	2 Kg 4.4 £	21 L 5.5 gal
6023/GR	65 cm 25.5 in	27,5 cm 10.8 in	3 Kg 6.6 £	39 L 10.3 gal

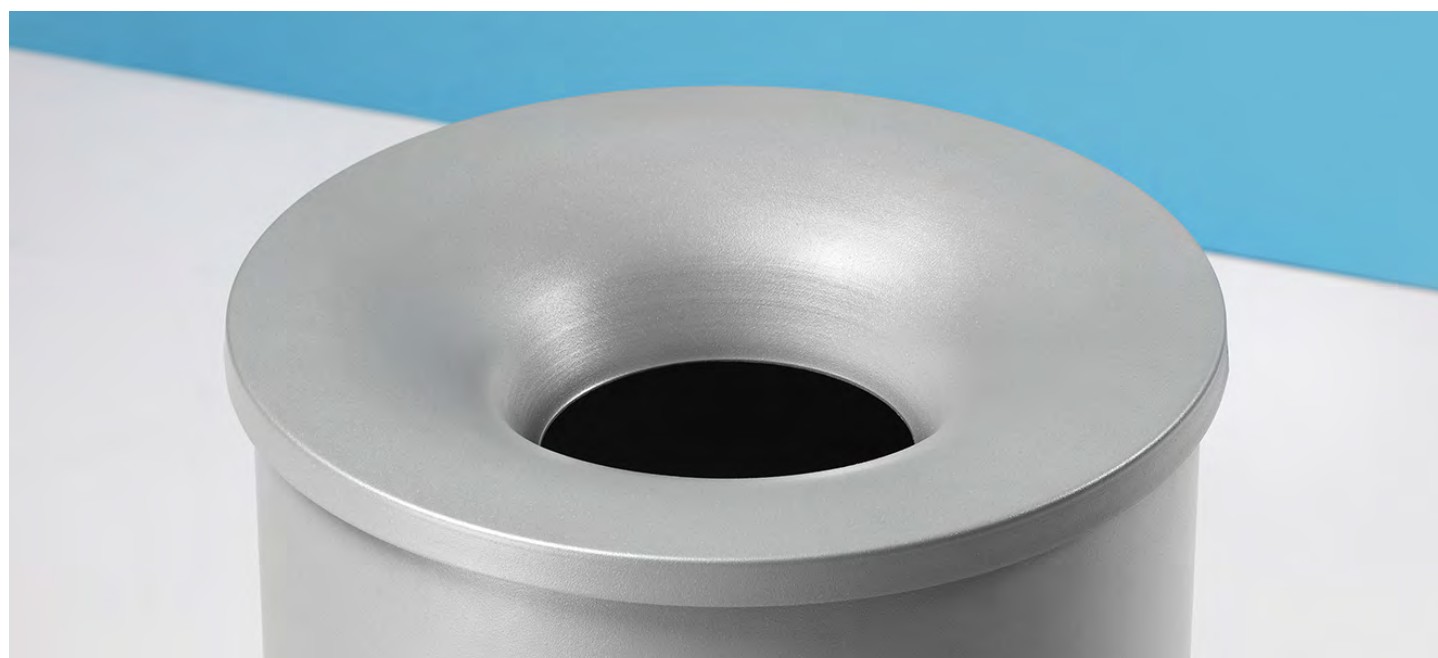

Swing Bins



Metallic waste bin painted with epoxy paint, with a medium-capacity hinged opening, ideal for shopping centers and public places. Available in white and grey color and 2 standard sizes. Head swingarm self closing. Includes hook for holding rubbish bags.

Papelera metálica pintada con pintura epoxi, con apertura batiente de mediana capacidad ideal para centros comerciales y espacios públicos. Disponible en color blanco y gris en 2 tamaños standard. Cabezal basculante auto cierre. Incluye ganchos sujeta bolsas.

Corbeille à papier métallique peinte avec de la peinture époxy, avec une ouverture basculante de capacité moyenne, idéale pour les centres commerciaux et les espaces publics. Disponible en blanc et gris 2 tailles standard. Tête inclinable à fermeture automatique. Crochets pour maintenir le sac inclus.

Sizes

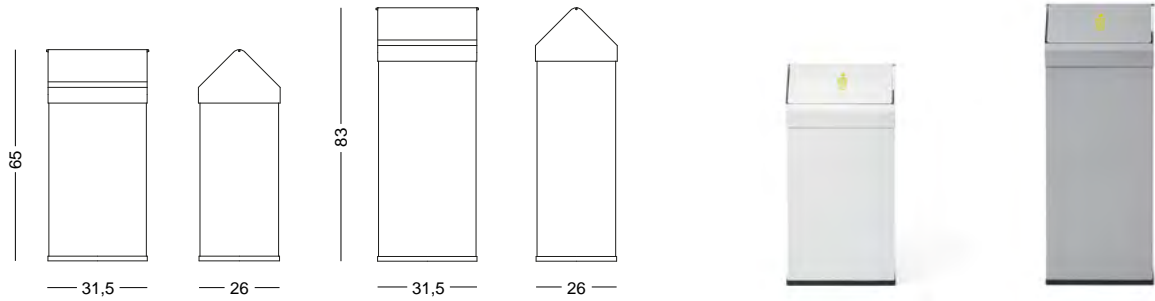

Options

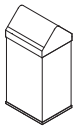

●	○	↕ ↔	👤	💧
6030/PL	6030/BL	65x31,5 cm 25.5x12.4 in	6 Kg 13.2 £	41 L 10.8 gal
6031/PL	6031/BL	83x31,5 cm 25.5x12.4 in	9 Kg 19.8 £	56 L 14.7 gal

Colors



Cubic Bins



Litter bin made with white epoxy painted sheet metal with a 30 x 30 cm square base. Available in 3 sizes enabling it to adapt in different areas/uses according to needs. 40, 60 and 80 cm. Tall. RAL 9003 white standard color and the possibility of choosing the vinyl for the required residues/wastes.

Papelera fabricada en chapa metálica pintada epoxi en color blanco con base cuadrada de 30 x 30 cm. Disponible en 3 tamaños para poder adaptar en diferentes espacios según necesidad. 40, 60 y 80 cm. de altura. Color estándar blanco RAL 9003 y posibilidad de elegir el vinilo para el residuo necesario.

Corbeille métallique peinte avec de la peinture époxy et une base carré de 30 x 30 cm. Disponible en 3 hauteurs pour pouvoir s'adapter dans différents espaces selon les besoins. 40, 60 et 80 cm. Couleur standard blanc RAL 9003 et possibilité de choisir le pictogramme pour le résidu souhaité.

Sizes

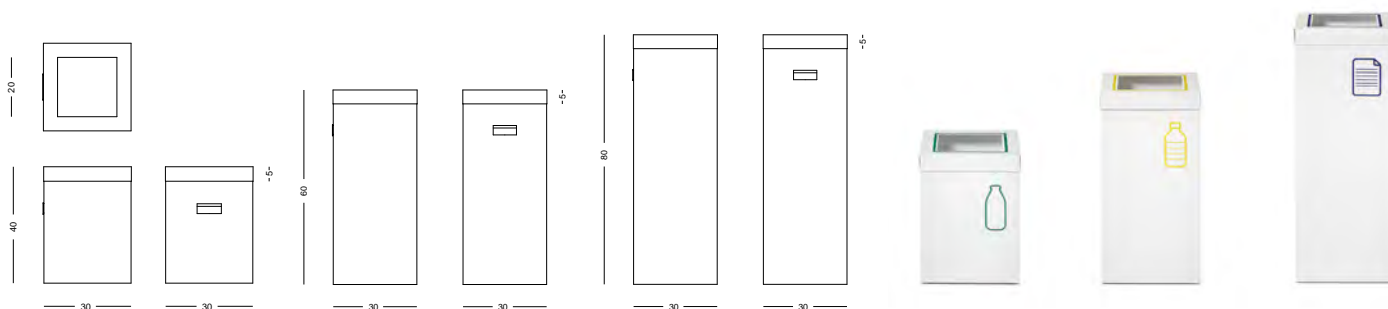

Options

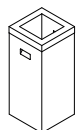

REF	↕ ↔	↔	⚖	💧
6056/1	40x30 cm 15.7x11.8 in	30 cm 11.8 in	3,5 Kg 7.7 £	36 L 9.5 gal
6056/2	60x30 cm 23.6x11.8 in	30 cm 11.8 in	5,1 Kg 11,2 £	54 L 14.2 gal
6056/3	80x30 cm 31.4x11.8 in	30 cm 11.8 in	6,6 Kg 14.5 £	72 L 19 gal



Pedal Bins



Pedal-operated waste bin made from white epoxy painted sheet metal with a 30 x 30 cm square base. Available in 2 sizes to be able to adapt in different areas according to needs. 60 and 80 cm. Tall. RAL 9003 white standard color and the possibility of choosing the vinyl for the required residues.

Papelera con accionamiento a pedal fabricada en chapa metálica pintada epoxi en color blanco con base cuadrada de 30 x 30 cm. Disponible en 2 tamaños para poder adaptar en diferentes espacios según necesidad. 60 y 80 cm. de altura. Color estándar blanco RAL 9003 y posibilidad de elegir el vinilo para el residuo necesario.

Corbeille à pédale métallique peinte avec de la peinture époxy avec une base carrée de 30 x 30 cm. Disponible en 2 tailles pour pouvoir s'adapter dans différents espaces selon les besoins. 60 et 80 cm. de hauteur. Couleur standard blanc RAL 9003 et possibilité de choisir le pictogramme pour le résidu souhaité.

Sizes

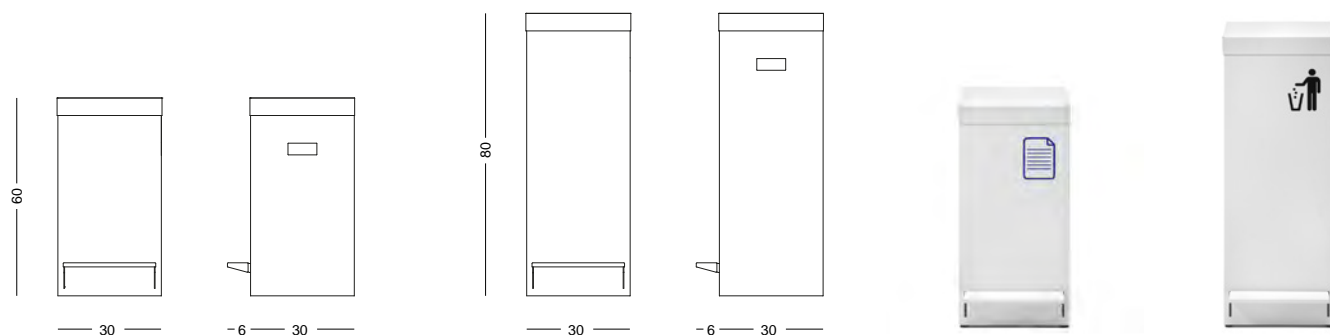

Options

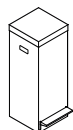

REF	↕ ↔	↔	⚖	💧
6056/2/PD	60x30 cm 23.6x11.8 in	30 cm 11.8 in	8 Kg 17.6 £	50 L 13.2 gal
6056/3/PD	80x30 cm 31.4x11.8 in	30 cm 11.8 in	10 Kg 22 £	70 L 18.4 gal



Recycling Station



White epoxy painted metal 120 liters recycling container to hold 3 types of waste, with hinged lid with 3 inner rings to hold plastic bags. Top lid with colored vinyls for differentiation of waste. White RAL 9003 standard color. Ideal for offices, public spaces with high volume of people.

Contenedor de reciclaje metálico pintado epoxi blanco de 120 litros de 3 residuos, papelera con tapa abatible con 3 aros interiores para sujeción de las bolsas de plástico. Tapa superior con vinilos de colores para la diferenciación de los residuos. Color standard blanco RAL 9003. Ideal para oficinas, espacios públicos con gran tráfico de personas.

"Conteneur de recyclage en métal peint époxy blanc de 120 litres de 3 types de déchets, poubelle avec couvercle à charnière avec 3 anneaux intérieurs pour contenir les sacs en plastique. Couvercle supérieur avec des pictogrammes colorés pour la différenciation des déchets. Couleur standard blanc RAL 9003. Idéal pour les bureaux, les espaces publics à fort trafic de personnes."

Sizes

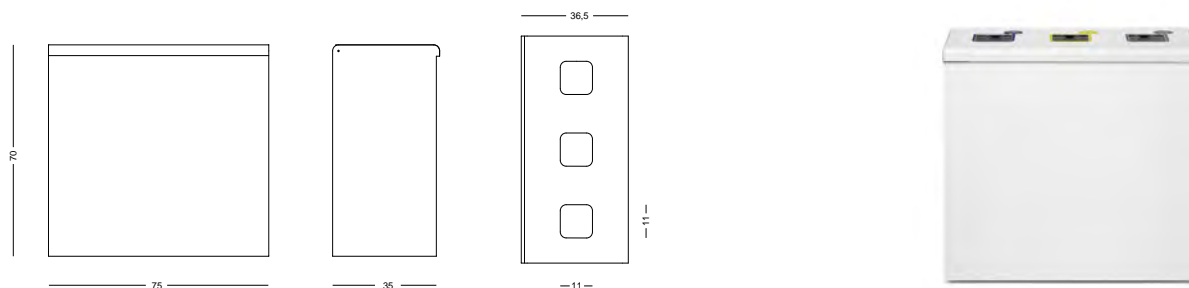

Options

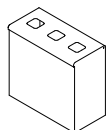

REF	↕ ↔	↔	📦	💧
6055/BL	70x75 cm 27.5x29.5 in	35 cm 13.7 in	24 Kg 52.9 £	120 L 31 gal

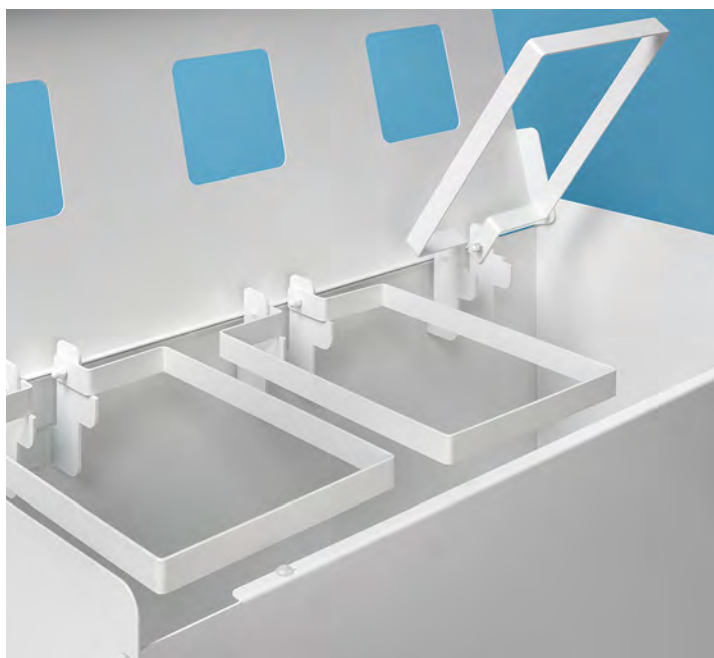

Metallic Bins



Grey epoxy painted metal recycling bin with 76 litre capacity, with hinged lid and inner ring for plastic bag. Top cap available in 4 basic recycling colors. Ideal for offices, shopping centers, and public places with large volumes of people.

Papelera de reciclaje metálica pintada epoxi gris de 76 litros de capacidad, con tapa abatible y aro interior para bolsa de plástico. Tapa superior disponible en 4 colores de reciclaje básicos. Ideal para oficinas, centros comerciales, y espacios públicos con gran afluencia de público.

Poubelle de recyclage en métal peint époxy gris d'une capacité de 76 litres, avec couvercle à charnière et anneau intérieur pour sac en plastique. Couvercle disponible en 4 couleurs de recyclage standard. Idéal pour les bureaux, les centres commerciaux et les espaces publics avec un grand nombre de personnes.

Sizes

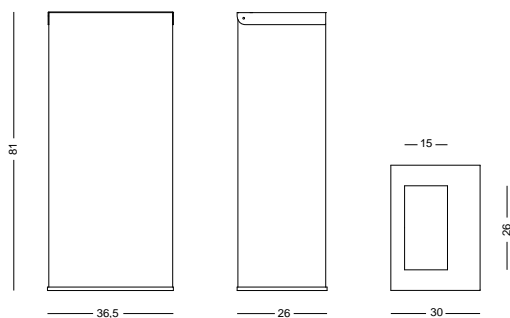

Options

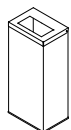

REF
6045

TOP CAP COLOUR
● /AZ ● /VD
● /AM ● /GR

↕ ↔
81x36,5 cm
31.8x14.3 in

↔
26 cm
10.2 in

👤
8 Kg
17.6 £

💧
76 L
20 gal



Inox Pedal Bins



Range of metal bins with foot pedal opening. They incorporate a black plastic tray with a handle and are available in 5, 12, 20 and 30 liters. Made of stainless steel. Ideal for bathrooms for both office and domestic use.

Gama de papeleras metálicas con apertura de pedal. Incorporan cubeta de plástico negro con asa y están disponibles en 5, 12, 20 y 30 litros. Fabricadas en acero inoxidable. Ideales para baños tanto para uso en oficinas como doméstico.

Gamme corbeilles métalliques avec ouverture à pédale. Contient un bac en plastique noir avec poignée et sont disponibles en 5, 12, 20 et 30 litres. Fabriqué en acier inoxydable. Idéal pour les salles de bain du bureau ou domestique.

Sizes

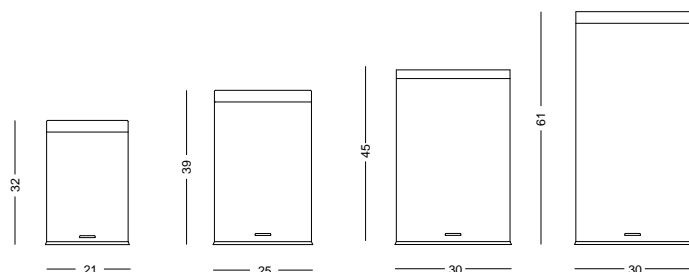

Options

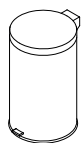

REF	Height	Width	Weight	Capacity
6050/I	32 cm 12.6 in	21 cm 8.3 in	1,2 Kg 2.6 £	5 L 1.3 gal
6051/I	39 cm 15.4 in	25 cm 9.8 in	1,9 Kg 4.1 £	12 L 3.1 gal
6052/I	45 cm 17.7 in	30 cm 11.8 in	2,7 Kg 5.9 £	20 L 5.2 gal
6053/I	61 cm 24 in	30 cm 11.8 in	3,5 Kg 7.7 £	30 L 7.9 gal



Plastic Pedal Bins



Recycling bin made from stainless steel effect plastic with foot pedal operated opening. Ideal for bathrooms and / or kitchens for both office and home use. Model available with a separator for two waste. Ideal for recycling.

Papelera de reciclaje de plástico efecto inox con apertura mediante accionamiento a pedal. Ideales para baños y/o cocinas tanto para uso en oficinas como uso doméstico. Modelo disponible con separador para dos residuos. Ideal para reciclaje.

Poubelle de recyclage en plastique effet inox avec ouverture à pédale. Idéal pour les salles de bain et / ou les cuisines pour le bureau et la maison. Modèle disponible avec un séparateur pour deux déchets. Idéal pour le recyclage.

6274

6544

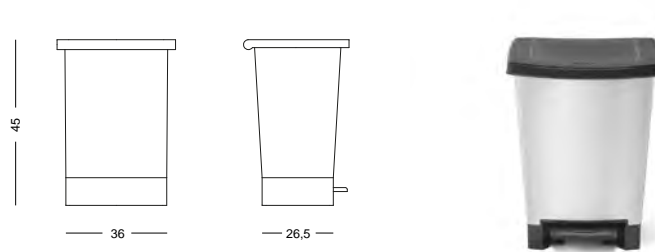
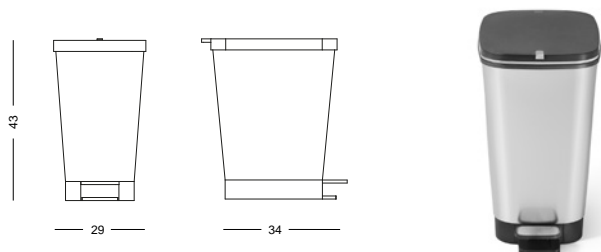

Sizes

REF	↕ ↔	↔	👤	💧
6274	43x29 cm 16.9x11.4 in	34 cm 13.3 in	3 Kg 6.6 £	20 L 5.2 gal

Sizes

REF	↕ ↔	↔	👤	💧
6544	45x36 cm 17.7x14.1 in	26,5 cm 10.4 in	3 Kg 6.6 £	25 L 6.6 gal

*
Divider for 2 waste included
Separador para 2 residuos incluido
Diviseur pour 2 déchets inclus



Plastic Pedal Bins



Rectangular recycling bin with foot pedal-operated opening made from white plastic, easy to empty and clean. Available in 2 sizes, has castors and a handle for easy movement.

Contenedor de reciclaje, rectangular con apertura mediante accionamiento de pedal fabricado de plástico de color blanco, fácil de vaciar y limpiar. Disponible en 2 tamaños, disponen de ruedas y asa para su fácil desplazamiento.

Conteneur de recyclage rectangulaire avec ouverture à pédale en plastique blanc, facile à vider et à nettoyer. Disponible en 2 dimensions. Elle a des roues et une poignée pour un déplacement facile.

6300/60

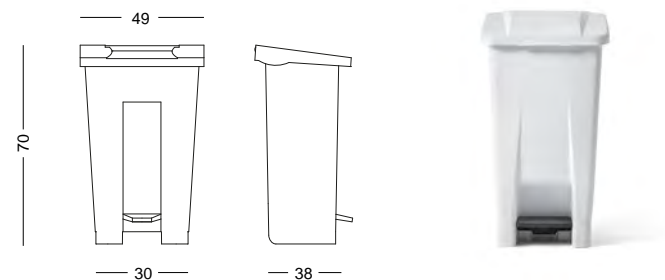

6410/80

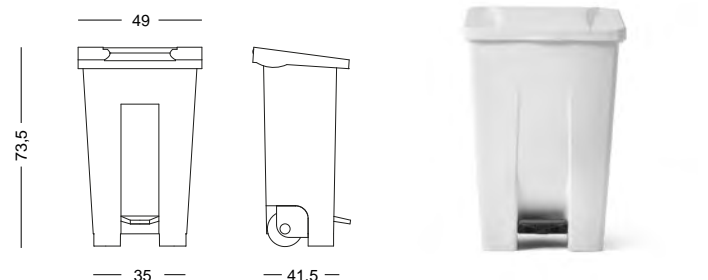

Sizes

REF	↕ ↔	↔	👤	💧
6300/60	70x49 cm 27.5x19.2 in	38 cm 14.9 in	3,7 Kg 8.1 £	60 L 15.8 gal

Sizes

REF	↕ ↔	↔	👤	💧
6410/80	73,5x49 cm 28.9x19.2 in	41,5 cm 16,1 in	4,6 Kg 10.1 £	80 L 21.1 gal



Outdoor Ashtray



Range of outdoor ashtrays.
Available in 3 versions floor or wall
mounted , all of them provided with
a security lock. Ideal for placing
at the entrances of public and
private places where smoking is
not allowed inside. Suitable for bad
weather.

Gama de ceniceros de exterior.
Disponibles en 3 modelos a suelo
o a pared todos ellos provistos con
cerradura de seguridad. Ideal para
situar en las entradas de espacios
públicos y privados donde no está
permitido fumar en el interior. Aptos
para intemperie.

*Gamme de cendriers d'extérieur.
Disponible en 3 modèles
différents. Soir muraux ou au sol,
tous équipés d'une serrure de
sécurité. Idéal pour placer aux
entrées des espaces publics et
privés. Résistant aux
intempéries.*



Outdoor Ashtray

BL/MO/0050



Size

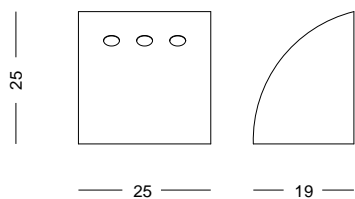

Data

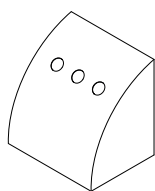

REF	↕↔	↔	⚖	💧
BL/MO/0050	25x25 cm 9.84x9.84 in	19 cm 7.48 in	2,1 Kg 4.6 £	1,4 L 3 gal

BL/MO/0051



Size

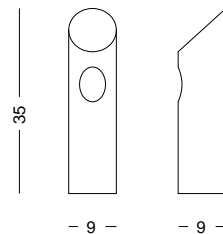

Data

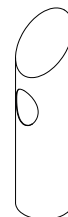

REF	↕	∅	⚖	💧
BL/MO/0051	35 cm 13.8 in	9 cm 3.54 in	1,5 Kg 3.3 £	0,6 L 1.3 gal

BL/MO/0052



Size

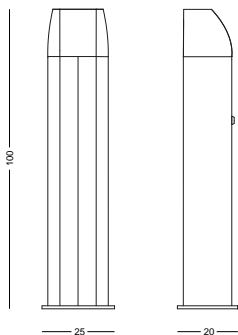

Data

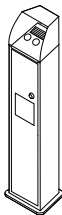

REF	↕ ↔	↔	👤	💧
BL/MO/0052	100x25 cm 39.3x9.8 in	20 cm 7.8 in	13 Kg 28.6 £	4,4 L 1.1 gal
	Ashtray capacity			1,2 L 0.3 gal
	Waste paper capacity			4,3 L 1.1 gal



Coat Stand



Range of metal coat racks made using tube with a round base giving great stability, with 8 golf type balls/hooks for hanging. Available in grey and chrome ball/hooks. Ideal for offices and co-working type work areas and in residential places.

Gama de percheros metálicos de tubo y base redonda de gran estabilidad, con 8 bolas y 6 ganchos a modo de percha. Disponible en color gris y bolas cromadas. Ideal para oficinas y zonas de trabajo tipo co-working y en espacios residenciales.

Porte-manteaux métalliques et base ronde d'une grande stabilité, avec 8 boules en guise de patères. Disponible en gris et patères chromées. Idéal pour les bureaux et les zones de travail de type coworking ou les espaces résidentiels.

6100

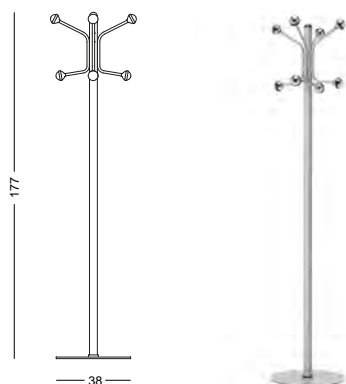

6110

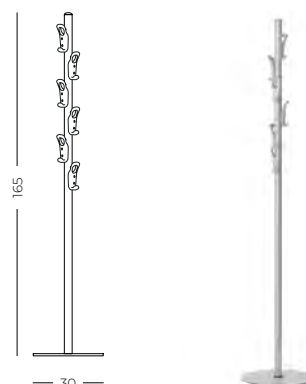

Colours



Sizes

REF	↕ ↔	∅	2	👤
6100	177 cm 69.6 in	38 cm 14.9 in	8	6,5 Kg 14.3 £

Sizes

●	●	○	↕ ↔	∅	2	👤
6110/GR	6110/NG	6110/BL	165 cm 36.3 in	38 cm 14.9 in	6	6 Kg 13.2 £

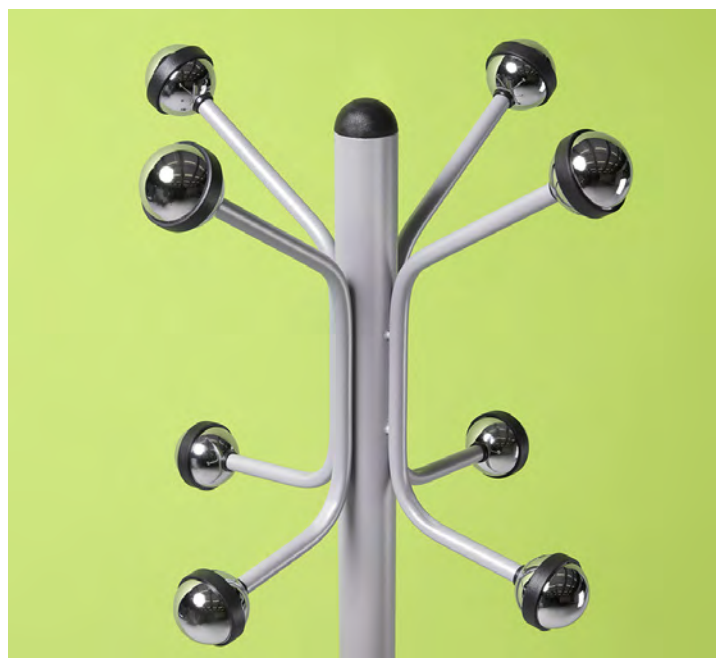

Wall Coat Rack



Collection of gray epoxy painted metal wall racks. Available in different sizes and in 3, 4 and 6 hangers. Ideal for both the office world and the home. Model 6120/GR optional with shelf for placing objects.

Colección de percheros murales metálicos pintados epoxi gris. Disponible en diferentes tamaños y en 3, 4 y 6 perchas. Ideales tanto como para el mundo de la oficina como el hábitat. El modelo 6120/GR opcional con repisa porta objetos.

Collection de portes-manteaux muraux métalliques peints époxy gris. Disponible en différentes tailles et en 3, 4 et 6 patères. Idéal pour le monde du bureau et l'habitat. Modèle 6120/GR en option avec étagère pour objets.

Sizes

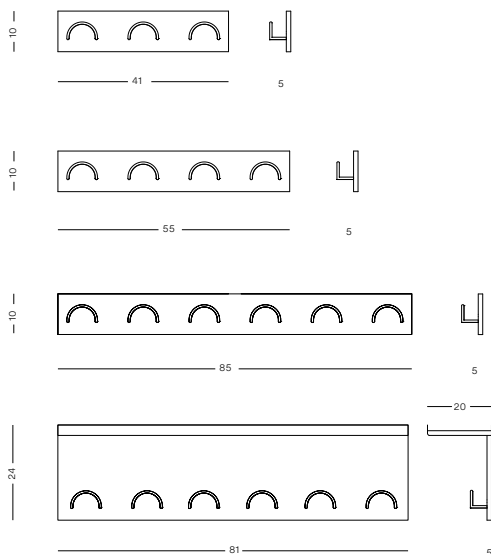

Colours



Options

REF	↕ ↔	👤	👤	→ K
6120/3	10x41 cm 3.9x16.1 in	3	0,36 Kg 0.79 £	5 cm 1.9 in
6120/4	10x55 cm 3.9x21.6 in	4	0,85 Kg 1.8 £	
6120/6	10x85 cm 3.9x33.4 in	6	1,31 Kg 2.8 £	
6120/6R	24x81 cm 9.4x31.8 in	6	3 Kg 6.6 £	



Eco 2 Coat Stand



Metal coat rack / umbrella stand made of \varnothing 4 cm round tube lightweight giving stability thanks to its base. 4 double hooks on the upper part painted in anthracite and white colors. Ideal for workplaces and home. Available in wall mounted version with 1, 3, 4 or 6 hangers.

Perchero/paragüero metálico de tubo redondo de \varnothing 4 cm. y de gran ligereza y estabilidad gracias a su base. 4 ganchos dobles en su parte superior pintados en colores antracita y blanco. Ideal para espacios de trabajo y el habitat. Disponibles en versión mural de 1, 3, 4 o 6 perchas

Porte-manteau / porte-parapluie métallique en tube rond \varnothing 4 cm. et d'une grande légèreté et stabilité grâce à sa base. 4 patères doubles sur la partie supérieure peints en anthracite ou blanc. Idéal pour les espaces de travail et l'habitat. Disponible en version murale avec 1, 3, 4 ou 6 patères.



Eco 2 Coat Stand

EC/02

EC/12

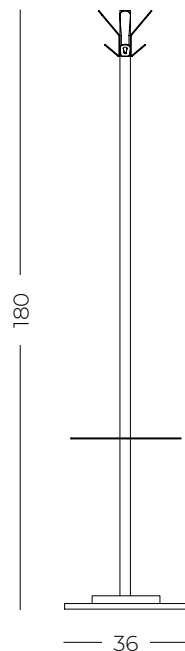
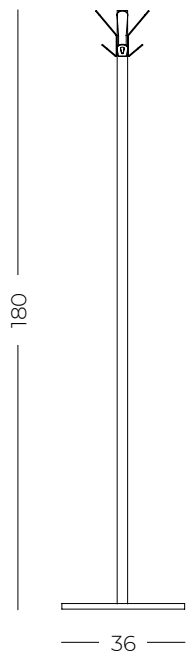

Specs



Colours



Data

<input type="radio"/>	<input checked="" type="radio"/>	↕	∅	⌒	⚖
EC/02/BL	EC/02/NG	180 cm 70.8 in	36 cm 14.1 in	8	9 Kg 19.8 £

Data

<input type="radio"/>	<input checked="" type="radio"/>	↕	∅	⌒	⚖
EC/12/BL	EC/12/NG	180 cm 70.8 in	36 cm 14.1 in	8	11,3 Kg 24.9 £

EC/P

EC/02/M

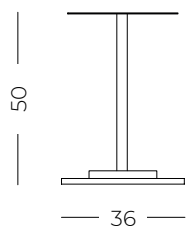

Specs



Colours



Data

○	●	↕	∅	⚖
EC/P/BL	EC/P/NG	50 cm 17.7 in	36 cm 14.1 in	6 Kg 13.2 £



Size

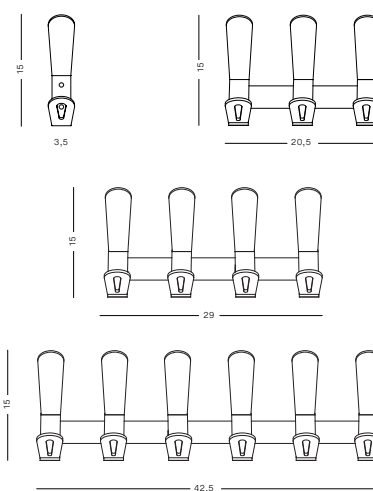

Data

○	●	↕ ↔	⌂	⚖
EC/02/M1/BL	EC/02/M1/NG	15x3,5 cm 5.9x15.3 in	1	0,1 Kg 0.2 £
EC/02/M3/BL	EC/02/M3/NG	15x20,5 cm 5.9x8 in	3	0,5 Kg 1.1 £
EC/02/M4/BL	EC/02/M4/NG	15x29 cm 5.9x11.4 in	4	0,7 Kg 1.5 £
EC/02/M6/BL	EC/02/M6/NG	15x42,5 cm 5.9x16.7 in	6	1 Kg 2.2 £

Eco 4 Coat Stand



Metal coat rack / umbrella stand made of \varnothing 3 cm round tube. This lightweight and stability is thanks to its base. 5 upper double hangers painted in anthracite and white. Ideal for workplaces and home. Available in a wall version with 3, 4 or 6 hangers.

Perchero/paragüero metálico de tubo redondo de \varnothing 3 cm. y de gran ligereza y estabilidad gracias a su base. 5 perchas dobles en su parte superior pintados en colores antracita y blanco. Ideal para espacios de trabajo y el hábitat. Disponibles en versión mural de 3, 4 o 6 perchas.

Porte-manteau / porte-parapluie métallique en tube rond \varnothing 3 cm. et d'une grande légèreté et stabilité grâce à sa base. 5 patères doubles sur la partie supérieure peintes en anthracite ou blanc. Idéal pour les espaces de travail et l'habitat. Disponible en version murale avec 3, 4 ou 6 patères.



Eco 4 Coat Stand

EC/04

EC/14

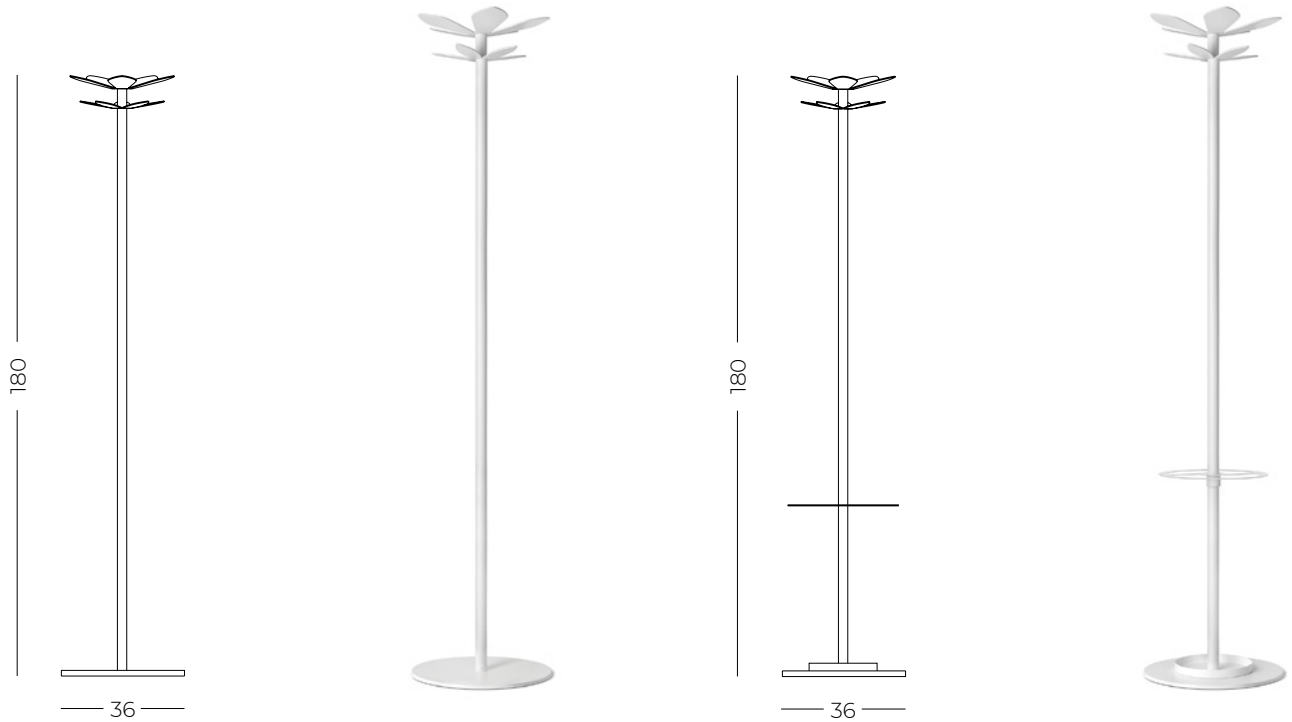

Specs



Colours



Data

<input type="radio"/>	<input checked="" type="radio"/>	↕	∅	⌒	⚖
EC/04/BL	EC/04/NG	180 cm 70.8 in	36 cm 14.1 in	10	9 Kg 19.8 £

Data

<input type="radio"/>	<input checked="" type="radio"/>	↕	∅	⌒	⚖
EC/14/BL	EC/14/NG	180 cm 70.8 in	36 cm 14.1 in	10	11,3 Kg 24.9 £

EC/P

EC/04/M

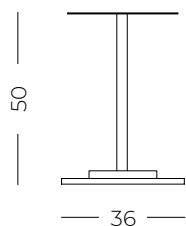

Specs



Colours



Data

○	●	↕	∅	⚖
EC/P/BL	EC/P/NG	50 cm 19.7 in	36 cm 14.1 in	6 Kg 13.2 £



Size

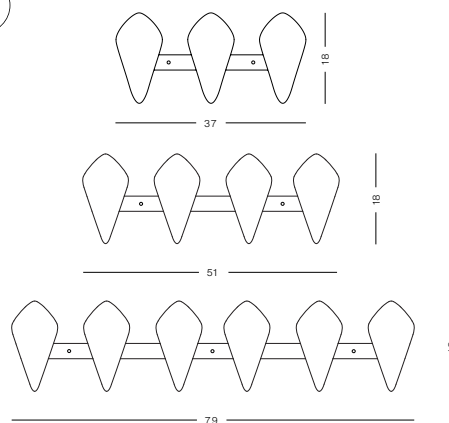

Data

○	●	↕ ↔	2	⚖
EC/04/M3/BL	EC/04/M3/NG	18x37 cm 7x14.5 in	3	0,7 Kg 1.5 £
EC/04/M4/BL	EC/04/M4/NG	18x51 cm 7x20 in	4	1 Kg 2.2 £
EC/04/M6/BL	EC/04/M6/NG	18x79 cm 7x31.1 in	6	1,5 Kg 3.3 £

Mobile Coat Rack



White epoxy painted metal coat rack with removable frame with castors for transport or storage. The lower part incorporates a shelf to place bags, suitcases, helmets... Ideal in offices, classrooms, etc...

Perchero metálico pintado epoxi blanco bastidor con ruedas de estructura demontable para transporte o almacenaje. La parte inferior incorpora un estante para colocar bolsos, maletas, cascos etc... Ideal en oficinas, aulas, guardarropas, etc...

Porte-manteau métallique peint en peinture époxy blanche avec chassis amovible et roulettes pour le transport ou le stockage. La partie inférieure intègre une étagère pour ranger sacs, valises, casques etc ... Idéal dans les bureaux, salles de classe, vestiaires, etc ...

Sizes

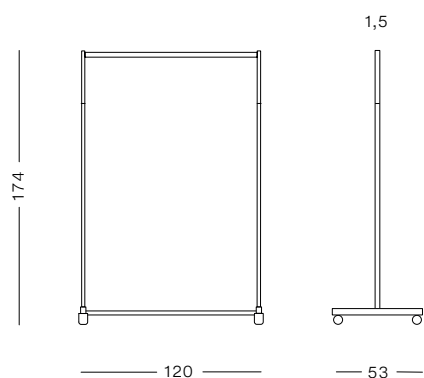

Data

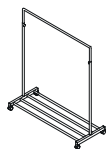

REF	↕ ↔	↔	📏
TS/BUR/R	174x120 cm 68.5x47.2 in	53 cm 20.8 in	5 Kg 11 £



Display Showcase



Square or rectangular modular display case made of metal layer and PMMA sides. (Methacrylate). 360° interior view. Hinged / Slide doors with lock. Available in 5 standard heights and 2 colours. Ideal for shops, exhibitions, museums ...

Vitrina expositora modular cuadrada o rectangular fabricada en chapa metálica y laterales de PMMA. (metacrilato). Vista interior de 360°. Puertas batientes o correderas dotadas con cerradura. Disponible en 5 alturas estándar y 2 colores. Ideales para comercios, exposiciones, museos...

Vitrine d'exposition modulaire carrée ou rectangulaire métallique et superficie transparente PMMA. (Méthacrylate). Vue intérieure à 360°. Portes battantes ou glissant avec serrure. Disponible en 5 hauteurs standard et 2 couleurs. Idéal pour les magasins, les expositions, les musées ...



Display showcase

Sizes

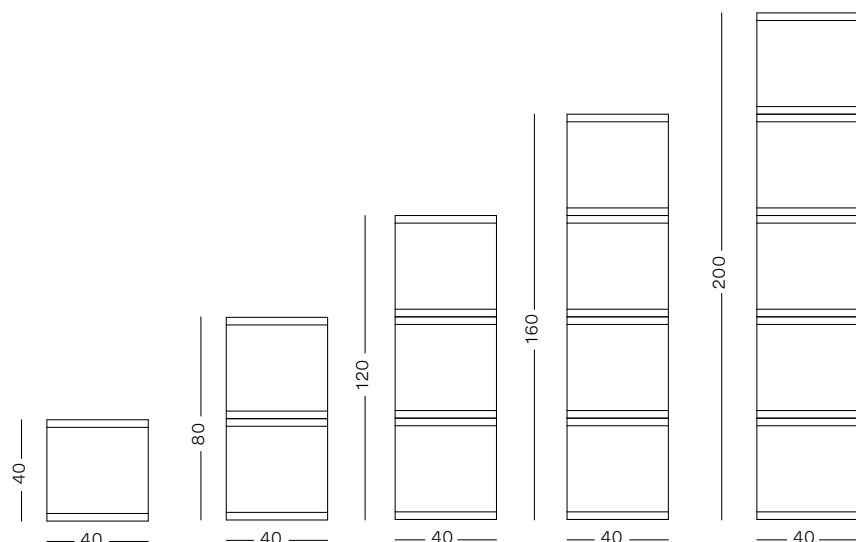

Colours



Options

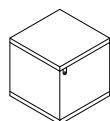

	○	●	↔↕	↔	⚖
VTR/01/BL	VTR/01/AN	40x40 cm 15.7x15.7 in	40 cm 15.7 in	15 Kg 33 £	
VTR/02/BL	VTR/02/AN	40x80 cm 15.7x31.4 in	40 cm 15.7 in	25 Kg 55.1 £	
VTR/03/BL	VTR/03/AN	40x120 cm 15.7x47.2 in	40 cm 15.7 in	35 Kg 77.1 £	
VTR/04/BL	VTR/04/AN	40x160 cm 15.7x62.9 in	40 cm 15.7 in	45 Kg 99.2 £	
VTR/05/BL	VTR/05/AN	40x200 cm 15.7x78.7 in	40 cm 15.7 in	55 Kg 121.2 £	

Sizes

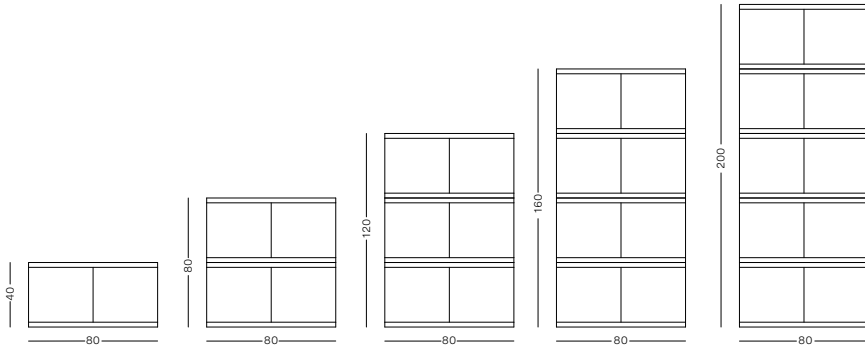
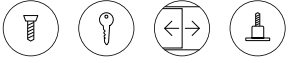

Colours



Options

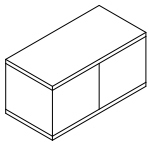

	○	●	↔↕	↔	⚖
VTR/11/BL	VTR/11/AN	80x40 cm 31.4x15.7 in	40 cm 15.7 in	25 Kg 55.1 £	
VTR/12/BL	VTR/12/AN	80x80 cm 31.4x31.4 in	40 cm 15.7 in	41 Kg 90.3 £	
VTR/13/BL	VTR/13/AN	80x120 cm 31.4x47.2 in	40 cm 15.7 in	57 Kg 125.6 £	
VTR/14/BL	VTR/14/AN	80x160 cm 31.4x62.9 in	40 cm 15.7 in	73 Kg 160.9 £	
VTR/15/BL	VTR/15/AN	80x200 cm 31.4x78.7 in	40 cm 15.7 in	89 Kg 196.2 £	

Signage System

GgHh

GgHhIiJj

GgHhIiJjKkLl

GgHhIiJjKkLlMm

GgHhIiJjKkLlMmNnÑñ

Consectetur adipiscing elit

- 1 Lorem ipsum dolor sit amet
- 2 Lorem ipsum dolor sit amet
- 3 Lorem ipsum dolor sit amet
- 4 Lorem ipsum dolor sit amet

Aa

AaBbCcDd

Zz

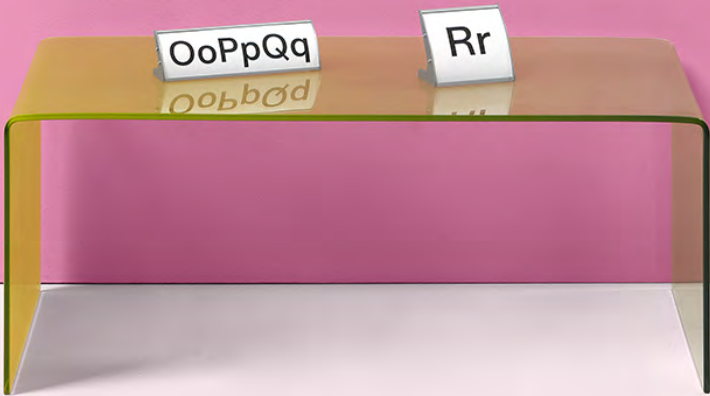

Curved profile signaling system for pictograms and labels for fixing to the ceiling or wall. It is made of anodized aluminum profile in matt silver color. The support allows the incorporation of the (pictogram or text paper). By means of a special suction cup the protective plastic is lifted to exchange the information. Ideal for indoor signage. Available in different lengths and 9 different heights.

Sistema de señalización de perfil curvo para pictogramas y rótulos para fijación en techo o pared. Está fabricado con perfil de aluminio anodizado en color plata mate. El soporte permite la incorporación del papel (pictograma o texto). Mediante una ventosa especial se levanta el plástico protector para intercambiar la información. Ideal para señalización de interiores. Disponible en diferentes largos y 9 alturas distintas.

Système de signalétique avec profil courbe pour pictogrammes et étiquettes à fixer au plafond ou au mur. Profilé en aluminium anodisé de couleur argent mat. Le support permet l'incorporation du pictogramme ou du papier texte. Grâce à une ventouse spéciale incluse, le plastique de protection est soulevé pour échanger les informations. Idéal pour la signalisation intérieure. Disponible en différentes longueurs et 9 hauteurs différentes.



Signage System

793/M (wall)

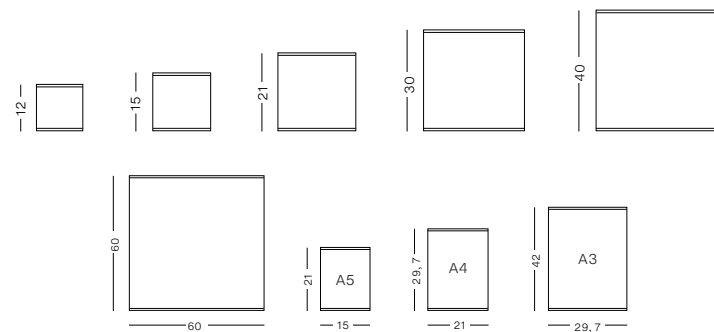

793/P (double sided flag)

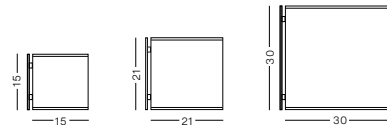

Options

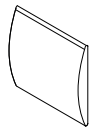

REF	↕ ↔	↗ ↖	⚖
793/M/12	12x12 cm 4.7x4.7 in	1 cm 0.3 in	0,2 Kg 0.4 £
793/M/15	15x15 cm 5.9x5.9 in	1,2 cm 0.4 in	0,2 Kg 0.4 £
793/M/21	21x21 cm 8.2x8.2 in	1,4 cm 0.5 in	0,4 Kg 0.8 £
793/M/30	30x30 cm 11.8x11.8 in	1,8 cm 0.7 in	1,3 Kg 2.8 £
793/M/40	40x40 cm 15,7x15,7 in	2 cm 0.7 in	2,2 Kg 4.8 £
793/M/60	60x60 cm 23.6x23.6 in	3 cm 1.1 in	4,5 Kg 9.9 £
793/M/A5	21x15 cm 8.2x5.9 in	1,2 cm 0.4 in	0,4 Kg 0.8 £
793/M/A4	29,7x21 cm 11.6x8.2 in	1,4 cm 0.5 in	0,6 Kg 1.4 £
793/M/A3	42x29,7 cm 16.5x11.6 in	1,8 cm 0.5 in	0,7 Kg 1.5 £

Options



REF	↕ ↔	↗ ↖	⚖
793/P/15	15x15 cm 5.9x5.9 in	2,4 cm 0.9 in	1,3 Kg 2.8 £
793/P/21	21x21 cm 8.2x8.2 in	2,8 cm 1.1 in	1,9 Kg 4.1 £
793/P/30	30x30 cm 11.8x11.8 in	3,6 cm 1.4 in	3,2 Kg 7 £



799/SB (desk)

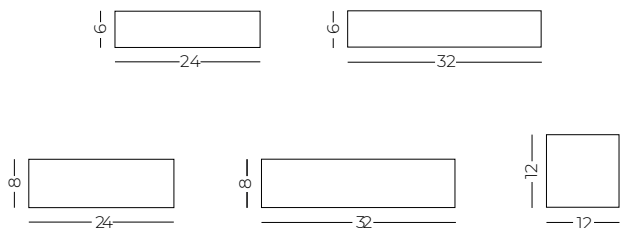

Options

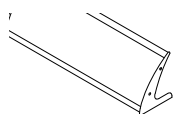

REF	↕ ↔	↗ ↖	⚖
799/6/24/SB	6x24 cm 2.3x9.4 in	0,8 cm 0.3 in	0,2 Kg 0.4 £
799/6/32/SB	6x32 cm 2.3x12.5 in	0,8 cm 0.3 in	0,2 Kg 0.4 £
799/8/24/SB	8x24 cm 3.1x9.4 in	1 cm 0.3 in	0,3 Kg 0.6 £
799/8/32/SB	8x32 cm 3.1x12.5 in	1 cm 0.3 in	0,3 Kg 0.6 £
799/12/12/SB	12x12 cm 4.7x4.7 in	1 cm 0.3 in	0,5 Kg 1.1 £

799/P (double sided flag)

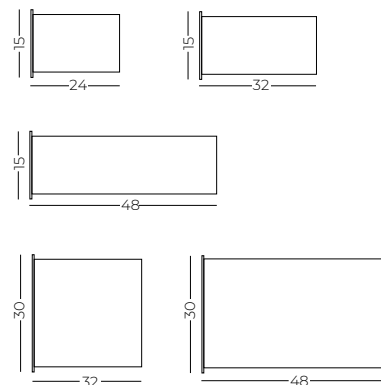

Options

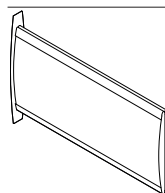

REF	↕ ↔	↗ ↖	⚖
799/15/24/P	15x24 cm 5.9x9.4 in	2,4 cm 0.9 in	1,2 Kg 2.6 £
799/15/32/P	15x32 cm 5.9x12.5 in	2,4 cm 0.9 in	1,4 Kg 3 £
799/15/48/P	15x48 cm 5.9x18.8 in	2,4 cm 0.9 in	2 Kg 4.4 £
799/30/32/P	30x32 cm 11.8x12.5 in	3,6 cm 1.4 in	4,6 Kg 10.1 £
799/30/48/P	30x48 cm 11.8x18.8 in	3,6 cm 1.4 in	5,1 Kg 11.2 £

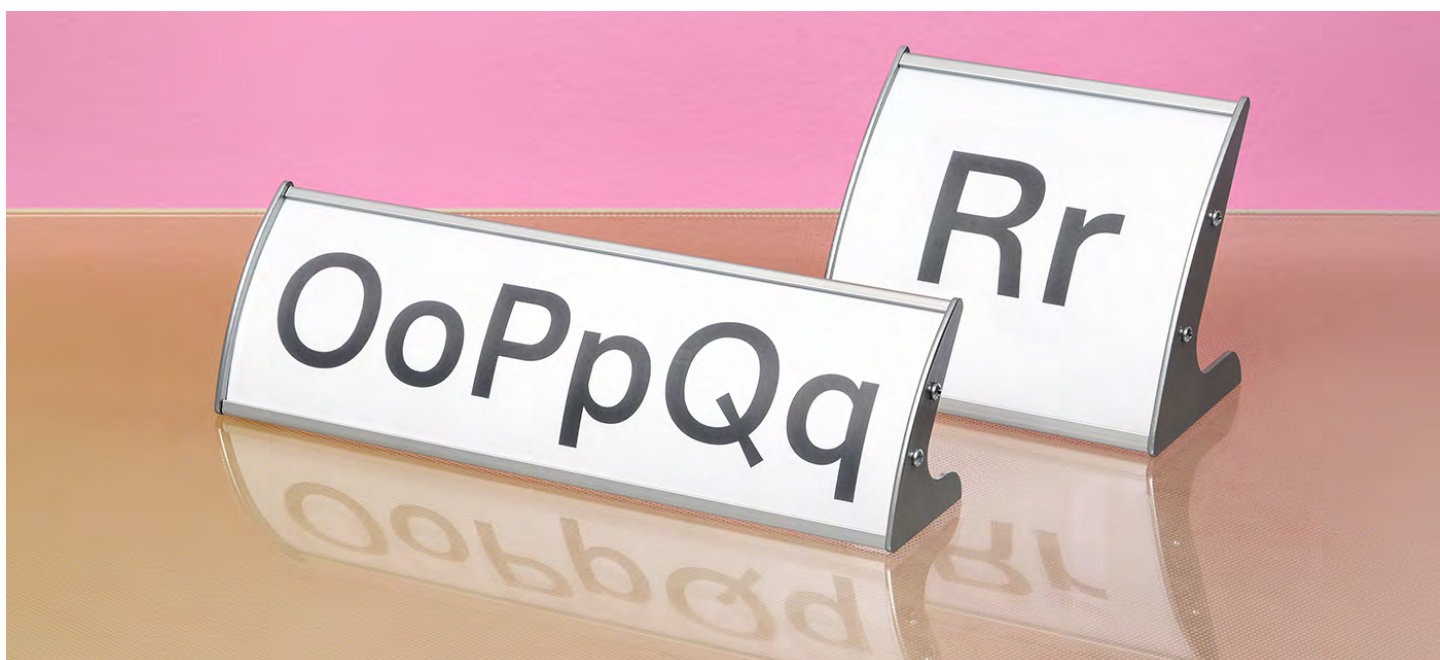

799/S (suspended)

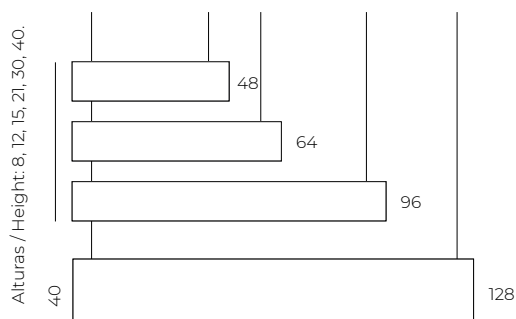

Options

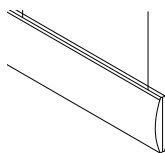

REF	↕ ↔	↗ ↖	👤
799/8/48/S	8x48 cm 3.1x18.8 in	2 cm 0.7 in	0,68 Kg 1.4 £
799/8/64/S	8x64 cm 3.1x25.1 in	2 cm 0.7 in	0,88 Kg 1.9 £
799/8/96/S	8x96 cm 3.1x37.7 in	2 cm 0.7 in	1,36 Kg 3 £
799/12/48/S	12x48 cm 4.7x18.8 in	2 cm 0.7 in	1,25 Kg 2.7 £
799/12/64/S	12x64 cm 4.7x25.1 in	2 cm 0.7 in	1,56 Kg 3.4 £
799/12/96/S	12x96 cm 4.7x37.7 in	2 cm 0.7 in	2,45 Kg 5.4 £
799/15/48/S	15x48 cm 5.9x18.8 in	2,4 cm 0.9 in	1,6 Kg 3.5 £
799/15/64/S	15x64 cm 5.9x25.1 in	2,4 cm 0.9 in	2,1 Kg 4.6 £
799/15/96/S	15x96 cm 5.9x37.7 in	2,4 cm 0.9 in	3,2 Kg 7 £
799/21/48/S	21x48 cm 8.2x18.8 in	2,4 cm 0.9 in	2,1 Kg 4.6 £
799/21/64/S	21x64 cm 8.2x25.1 in	2,4 cm 0.9 in	2,6 Kg 5.7 £
799/21/96/S	21x96 cm 8.2x37.7 in	2,4 cm 0.9 in	4,1 Kg 9 £
799/30/48/S	30x48 cm 11.8x18.8 in	3,6 cm 1.4 in	4,4 Kg 9.7 £
799/30/64/S	30x64 cm 11.8x25.1 in	3,6 cm 1.4 in	5,52 Kg 12.1 £
799/30/96/S	30x96 cm 11.8x37.7 in	3,6 cm 1.4 in	8,7 Kg 19.1 £
799/40/64/S	40x64 cm 15.7x25.1 in	4 cm 1.5 in	6,5 Kg 14.3 £
799/40/96/S	40x96 cm 15.7x37.7 in	4 cm 1.5 in	10,1 Kg 22.2 £
799/40/128/S	40x128 cm 15.7x50.3 in	4 cm 1.5 in	13 Kg 28.6 £

799/M (wall)

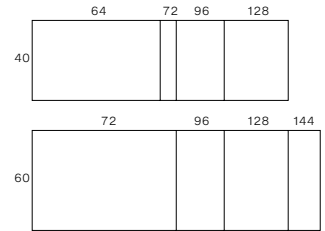
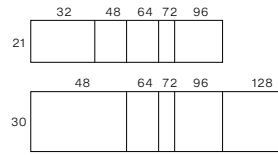
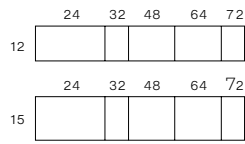
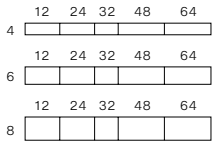

Options

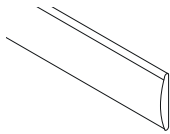

REF	↕ ↔	↗ ↖	⊕	REF	↕ ↔	↗ ↖	⊕
799/4/12/M	4x12 cm 1.5x4.7 in	0,8 cm 0.3 in	0,04 Kg 0.1 £	799/15/72/M	15x72 cm 5,9x28.3 in	1,2 cm 0.4 in	1,5 Kg 3.3 £
799/4/24/M	4x24 cm 1.5x9.4 in	0,8 cm 0.3 in	0,08 Kg 0.2 £	799/21/32/M	21x32 cm 8.2x12.5 in	1,2 cm 0.4 in	0,6 Kg 1.3 £
799/4/32/M	4x32 cm 1.5x12.5 in	0,8 cm 0.3 in	0,11 Kg 0.2 £	799/21/48/M	21x48 cm 8.2x18.8 in	1,2 cm 0.4 in	1 Kg 2.2 £
799/4/48/M	4x48 cm 1.5x18.8 in	0,8 cm 0.3 in	0,2 Kg 0.4 £	799/21/64/M	21x64 cm 8.2x25.1 in	1,2 cm 0.4 in	1,3 Kg 2.9 £
799/4/64/M	4x64 cm 1.5x25.1 in	0,8 cm 0.3 in	0,2 Kg 0.5 £	799/21/72/M	21x72 cm 8.2x28.3 in	1,2 cm 0.4 in	1,6 Kg 3.5 £
799/6/12/M	6x12 cm 2.3x4.7 in	0,8 cm 0.3 in	0,06 Kg 0.1 £	799/21/96/M	21x96 cm 8.2x37.7 in	1,2 cm 0.4 in	1,5 Kg 3.3 £
799/6/24/M	6x24 cm 2.3x9.4 in	0,8 cm 0.3 in	0,1 Kg 0.3 £	799/30/48/M	30x48 cm 11.8x18.8 in	1,8 cm 0.7 in	2,2 Kg 4.8 £
799/6/32/M	6x32 cm 2.3x12.5 in	0,8 cm 0.3 in	0,18 Kg 0.4 £	799/30/64/M	30x64 cm 11.8x25.1 in	1,8 cm 0.7 in	2,7 Kg 6 £
799/6/48/M	6x48 cm 2.3x18.8 in	0,8 cm 0.3 in	0,27 Kg 0.6 £	799/30/72/M	30x72 cm 11.8x28.3 in	1,8 cm 0.7 in	3,5 Kg 7.7 £
799/6/64/M	6x64 cm 2.3x25.1 in	0,8 cm 0.3 in	0,3 Kg 0.6 £	799/30/96/M	30x96 cm 11.8x37.7 in	1,8 cm 0.7 in	4,3 Kg 9.4 £
799/8/12/M	8x12 cm 3.1x4.7 in	1 cm 0.3 in	0,08 Kg 0.17 £	799/30/128/M	30x128 cm 11.8x50.3 in	1,8 cm 0.7 in	5,4 Kg 11.9 £
799/8/24/M	8x24 cm 3.1x9.4 in	1 cm 0.3 in	0,17 Kg 0.8 £	799/40/64/M	40x64 cm 15.7x25.1 in	2 cm 0.7 in	3,2 Kg 7 £
799/8/32/M	8x32 cm 3.1x12.5 in	1 cm 0.3 in	0,2 Kg 0.4 £	799/40/72/M	40x72 cm 15.7x28.3 in	2 cm 0.7 in	4 Kg 8.8 £
799/8/48/M	8x48 cm 3.1x18.8 in	1 cm 0.3 in	0,34 Kg 0.7 £	799/40/96/M	40x96 cm 15.7x37.7 in	2 cm 0.7 in	5 Kg 11 £
799/8/64/M	8x64 cm 3.1x25.1 in	1 cm 0.3 in	0,4 Kg 0.9 £	799/40/128/M	40x128 cm 15.7x50.3 in	2 cm 0.7 in	6,5 Kg 14,3 £
799/8/96/M	8x96 cm 3.1x37.7 in	1 cm 0.3 in	0,66 Kg 1 £	799/60/72/M	60x72 cm 23.6x28.3 in	2 cm 0.7 in	6 Kg 13.2 £
799/12/24/M	12x24 cm 4.7x9.4 in	1 cm 0.3 in	0,3 Kg 0.6 £	799/60/96/M	60x96 cm 23.6x37.7 in	2 cm 0.7 in	7,4 Kg 16.3 £
799/12/32/M	12x32 cm 4.7x12.5 in	1 cm 0.3 in	0,4 Kg 0.8 £	799/60/128/M	60x128 cm 23.6x50.3 in	2 cm 0.7 in	11,6 Kg 25.5 £
799/12/48/M	12x48 cm 4.7x18.8 in	1 cm 0.3 in	0,6 Kg 1.3 £	799/60/144/M	60x144 cm 23.6x56.6 in	2 cm 0.7 in	12 Kg 26.4 £
799/12/64/M	12x64 cm 4.7x25.1 in	1 cm 0.3 in	0,7 Kg 1.5 £				
799/12/72/M	12x72 cm 4.7x28.3 in	1 cm 0.3 in	1,2 Kg 2.6 £				
799/15/24/M	15x24 cm 5.9x9.4 in	1,2 cm 0.4 in	0,4 Kg 0.8 £				
799/15/32/M	15x32 cm 5.9x12.5 in	1,2 cm 0.4 in	0,5 Kg 1.1 £				
799/15/48/M	15x48 cm 5.9x18.8 in	1,2 cm 0.4 in	0,8 Kg 1.7 £				
799/15/64/M	15x64 cm 5.9x25.1 in	1,2 cm 0.4 in	1 Kg 2.2 £				

Display

Snap Frames	276
Lecterns Snap Frames	280
Picture Hanging Rail	284
Grid Panel	286
Premium Guide Posts	290
Accessories	294
Next Eco	296
Basic Guide Posts	298

Communicate, exhibit, show ... should be done in an orderly manner. At Planning Sisplamo we want to collaborate by offering a range of products that not only communicate or display clearly, we have strived to achieve a product that generates an environment according to each necessity, a poster or advertisement, a menu in a restaurant, the cordoning off of a space in a museum, or a brochure holder at a fair, are some of the accessories we offer in this product family. We intend to offer an efficient range.

Comunicar, exhibir, mostrar... debe hacerse de manera ordenada. En Planning Sisplamo queremos colaborar ofreciendo una gama de productos que no solo comuniquen o exhiban con claridad, nos hemos esforzado en lograr un producto que genere un espacio acorde a cada necesidad, un póster o anuncio, un menú en una cafetería, la delimitación de un espacio en un museo, o un portafolletos en una feria, son algunos de los complementos que ofrecemos en esta familia de productos. Pretendemos ofrecer una gama eficaz.

Communiquer, exposer, montrer ... doit se faire de manière ordonnée. Chez Planning Sisplamo nous voulons collaborer en offrant une gamme de produits qui communiquent ou affichent clairement. Nous nous sommes efforcés à réaliser un produit qui génère un espace en fonction de chaque besoin, une affiche ou une publicité, un menu dans une cafétéria, la délimitation d'un espace dans un musée, ou d'un porte-brochures lors d'une foire, sont quelques-uns des accessoires que nous proposons dans cette famille de produits. Il s'agit d'une gamme performante et efficace.



Display

Snap Frames



Poster presentation system, with a folding frame made from matt silver anodized aluminum with a miter, which allows the substitution of the poster/notice in a quick and convenient way. Available in wall option and on aluminum supports with brochure holder shelf or option of supports only with metallic brochure holder shelves.

Sistema de presentación de pósters, con marco abatible de aluminio anodizado en plata mate a inglete, que permite la sustitución del impreso de una manera rápida y cómoda. Disponible en opción mural y sobre soportes de aluminio con estante portafolletos u opción de soportes solo con estantes metálicos portafolletos.

Système de présentation d'affiches, cadre à bord rabatable en aluminium anodisé argent mat, qui permet la substitution du support de façon rapide et confortable. Disponible en version murale et sur supports en aluminium avec étagère porte-brochures ou en option supports uniquement avec étagères métalliques porte-brochures.



Snap Frames

832



Size

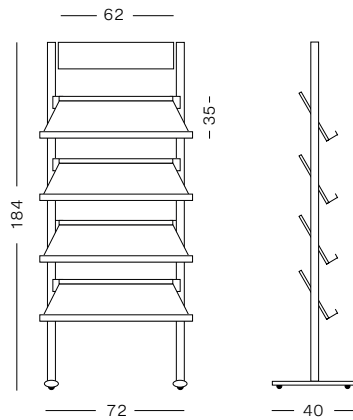

Data

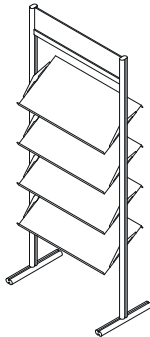

REF	↕ ↔	↔	⚖
832/4	184x72 cm 72.4x28.3 in	40 cm 15.7 in	22 Kg 48.5 £

2400



Size

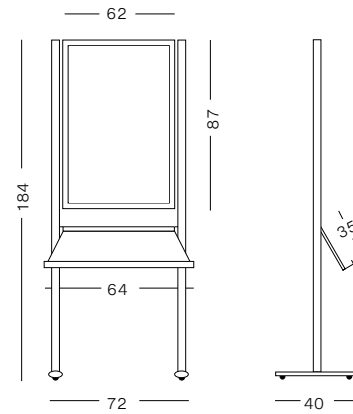

Data

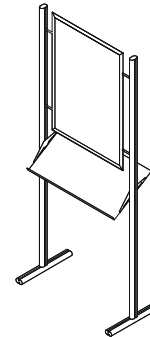

REF	↕ ↔	↔	⚖	📄
2400/IB	184x72 cm 72.4x28.3 in	40 cm 15.7 in	17 Kg 37.4 £	A1

850

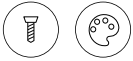

Size

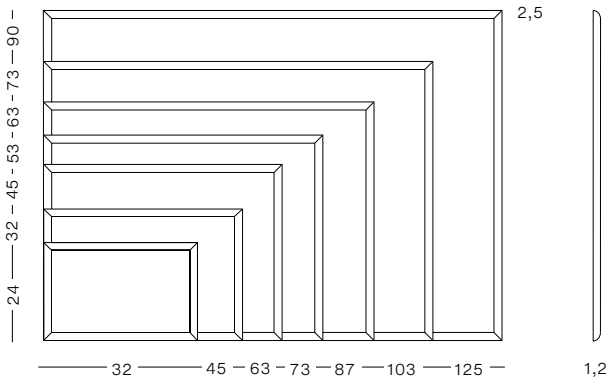

Data



REF	↕ ↔ INT.	↕ ↔ EXT.	⚖	📄	1,2 cm 0.4 in
850//M0	82x117 cm 32.2x46.06 in	89,5x124,3 cm 35.2x49 in	4 Kg 8.8 £	A0	
850//M1	59,4x84 cm 23.3x33 in	62,4x87,1 cm 24.5x34.2 in	2 Kg 4.4 £	A1	
850//M2	42x59,4 cm 16.5x23.3 in	45x62,4 cm 17.7x24.4 in	1,5 Kg 3.3 £	A2	
850//M3	70x100 cm 27.6x39.4 in	73x103 cm 28.7x40.5 in	3 Kg 6.6 £	70x100	
850//M4	50x70 cm 19.7x27.6 in	53x73 cm 20.8x28.7 in	1,7 Kg 3.7 £	50x70	
850//M5	42x29,7 cm 16.5x11.6 in	32,7x45 cm 12.8x17.7 in	0,7 Kg 1.5 £	A3	
850//M6	21x29,7 cm 8.2x11.6 in	24x32,7 cm 9.4x12.8 in	0,5 Kg 1.1 £	A4	



Lecterns Snap Frames



Range of fixed or height-adjustable display stands, made from aluminum with a folding frame to display all kinds of documents or information, brochures, menus, etc ... The upper Din A4 and Din A3 poster holder allows you to change to either vertical or horizontal positions and the adjustable version allows the inclination to vary from 0° to 90°.

Gama de atriles expositores fijos o graduables en altura, fabricados en aluminio con marco abatible para exponer toda clase de documentos o información, catálogos, menús, etc... El portapóster superior Din A4 y Din A3 permite adaptarse al soporte en posición vertical y horizontal y la versión graduable permite variar la inclinación de 0° a 90°.

Gamme de présentoirs fixes ou réglables en hauteur, en aluminium avec un cadre à bord rabattable pour afficher toutes sortes de documents ou d'informations, catalogues, menus, etc ... Le porte-affiche supérieur Din A4 et Din A3 permet de s'adapter au support en position verticale et horizontale et la version réglable permet une inclinaison de 0° à 90°.

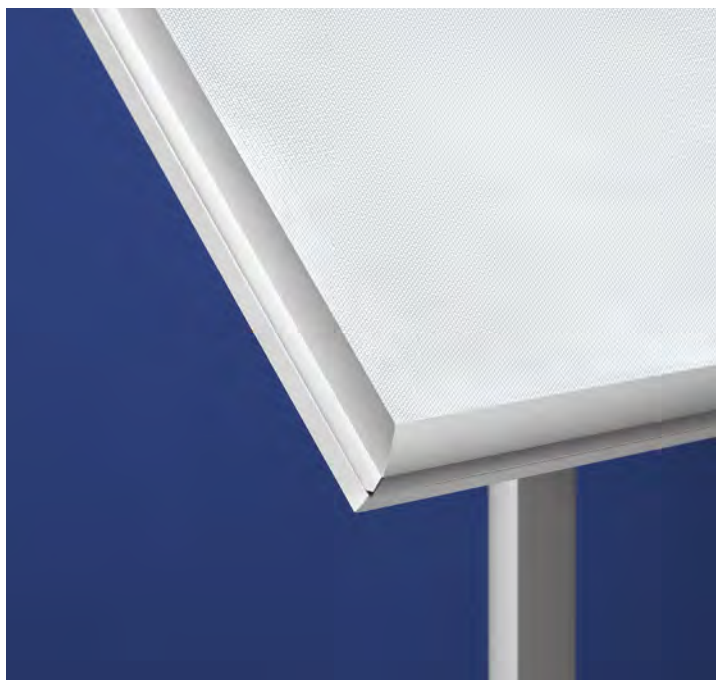
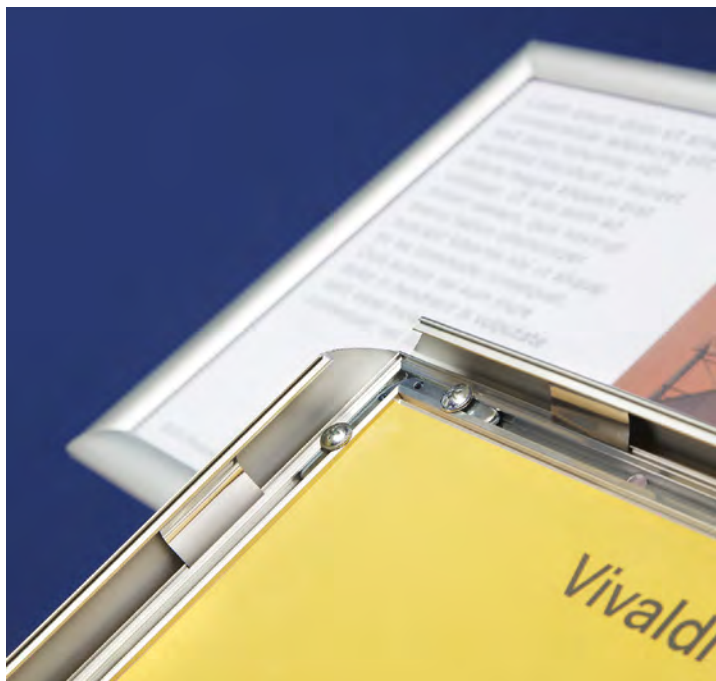

Lecterns Snap Frames

821



Size

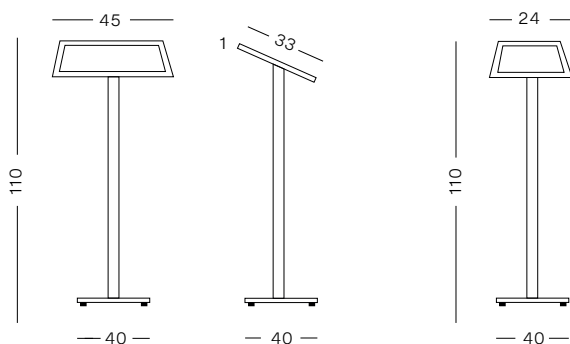

Data

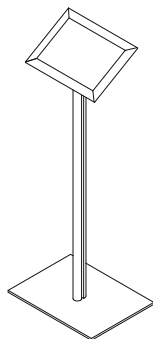
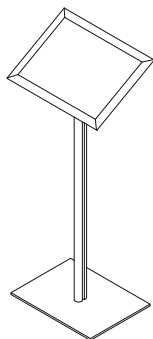

REF	↕ ↔	↔	□	⚖	📄
821/A3	110x30 cm 43.3x11.8 in	40 cm 15.7 in	29,7x42 cm 11.6x16.5 in	6,7 Kg 14.7 £	A3
821/A4	110x30 cm 43.3x11.8 in	40 cm 15.7 in	21x29,7cm 8.2x11.6 in	5,1 Kg 11.2 £	A4

822



Size

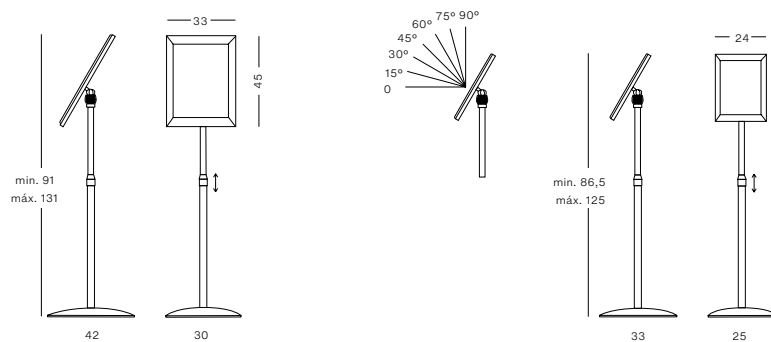

Data

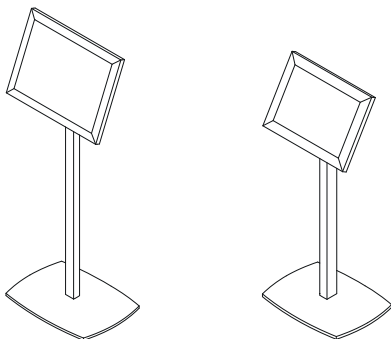

REF	↕ MAX. ~ MIN.	↔	IN	EXT		
822/A3	131 ~ 91 cm 51.5 ~ 35.8 in	42x30 cm 16.5x11.8 in	29,7x42 cm 11.6x16.5 in	33x45 cm 13x17.7 in	6,4 Kg 14.1 £	A3
822/A4	125 ~ 86,5 cm 49.2 ~ 34 in	33x24 cm 12.9x9.4 in	21x29,7cm 8.2x11.6 in	24x33 cm 9.4x13 in	6,3 Kg 13.8 £	A4

Picture Hanging Rail



Anodized aluminum wall rail in matt silver color, to hang posters and / or paintings. It allows them to be changed without having to screw them into the wall and move them longitudinally. Ideal for halls, art galleries, traveling exhibitions, receptions, etc. The 200 cm kit. Includes a set of 2 nylon cables and tie clips.

Rail de aluminio mural anodizado en color plata mate, para colgar pósters y/o cuadros. Permite cambiarlos sin tener que atornillarlos en la pared y desplazarlos longitudinalmente. Ideales para salas, galerías de arte, exposiciones itinerantes, recepciones, etc. El kit de 200 cm. incluye un juego de 2 cables de nylon y ganchos de sujeción.

Rail mural en aluminium anodisé de couleur argent mat, pour accrocher des affiches et / ou des peintures. Il permet de les changer sans avoir à les fixer au mur ou les déplacer longitudinalement. Idéal pour les salles, galeries d'art, expositions itinérantes, réceptions, etc. Le kit de 200 cm. comprend un ensemble de 2 câbles en nylon et des pinces.

Sizes

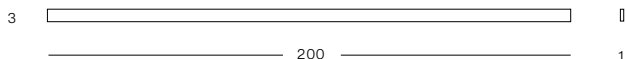

Options

REF	↕ ↔	↗ ↖	👤	
CC/150	3x200 cm 1.1x78.7 in	1 cm 0.3 in	0,3 Kg 0.6 £	RAIL + 2 CABLES
CC/1	150 cm 59 in		0,04 Kg 0.08 £	CABLE EXTRA

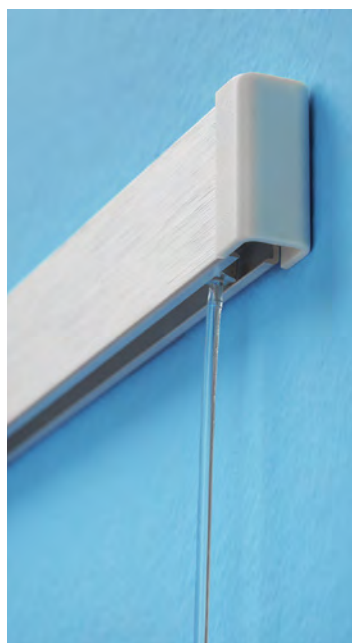

Grid Panel



Black epoxy painted metal grill panels, made of 0.5 cm iron rod forming a 7x7 cm mesh. It can be hung on the wall or mounted with "T" feet with castors. On the panel we can place an extensive range of accessories made with the same metal rod. Ideal for shops, exhibitions, etc...

Paneles rejilla metálicos pintados epoxi en color negro, fabricados con varilla de hierro de 0,5 cm. formando una malla de 7x7 cm. Puede colgarse a la pared o montarse con pies forma "T" con ruedas. Sobre el panel podemos situar una extensa gama de accesorios fabricados con la misma varilla metálica. Ideales para comercios, exposiciones, etc...

Grille d'exposition métalliques peintes époxy noir, fabriquées avec des tiges en fer de 0,5 cm. de grosseur formant une maille de 7x7 cm. Il peut être accroché au mur ou monté avec des pieds en «T» à roulettes. Sur la grille, nous pouvons placer une vaste gamme d'accessoires fabriqués avec la même tige métallique. Idéal pour les boutiques, expositions, etc...

Sizes

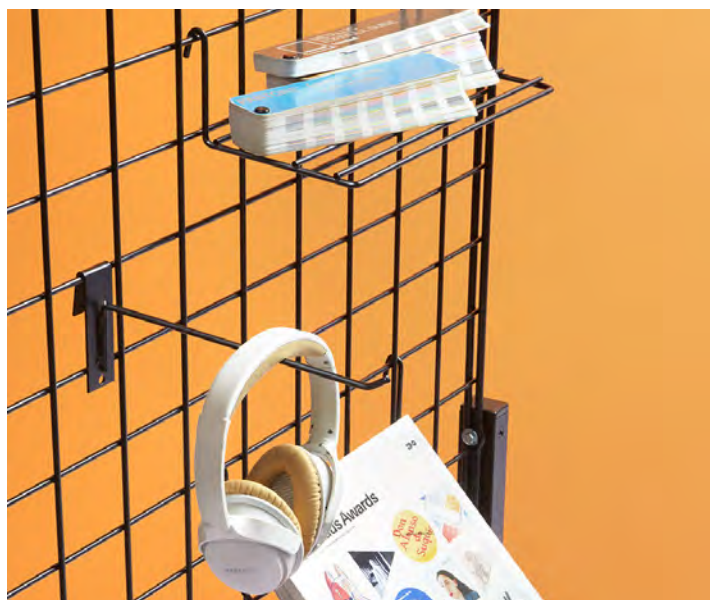
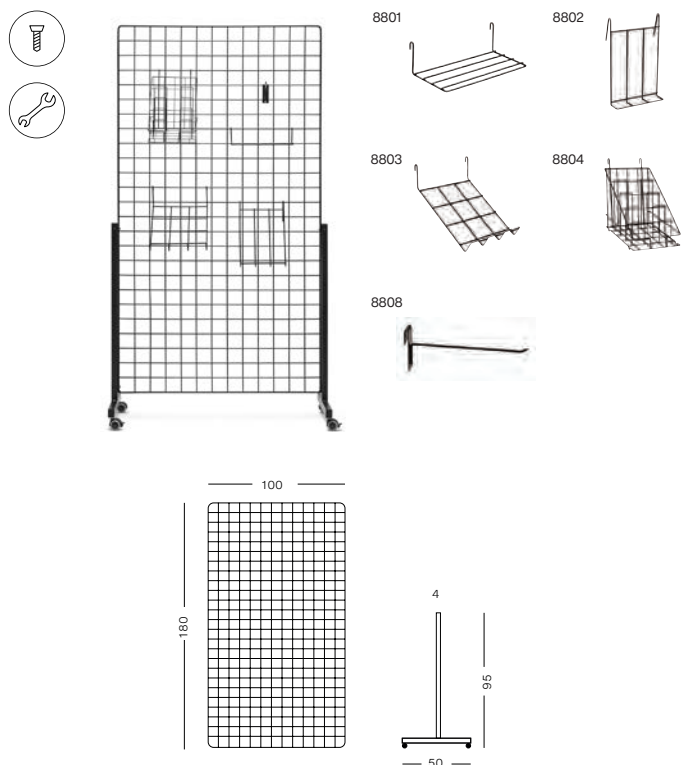

Options

REF	↕ ↔	↗ ↘	👤	
880	180x100 cm 70.8x39.3 in	0,5 cm 0.1 in	10 Kg 22 £	GRID
881	95x50 cm 37.4x19.6 in	4 cm 1.5 in	4 Kg 8.8 £	SUPPORT (1 UNIT)

ACCESSORIES

REF	↕ ↔	↗ ↘	👤	
8801	9,5x30 cm 3.7x11.8 in	14 cm 5.5 in	0,3 Kg 0.6 £	SHELF
8802	35x22 cm 13.7x8.6 in	5 cm 1.9 in	0,3 Kg 0.6 £	VERTICAL SHELF
8803	5x27 cm 1.9x10.6 in	38 cm 14.9 in	0,4 Kg 0.8 £	INCL. SHELF
8804	29,5x22 cm 11.6x8,6 in	24 cm 9.4 in	0,5 Kg 1.1 £	MAGAZINE RACK
8808	9,5x3 cm 3.7x1.1 in	27 cm 10.6 in	0,1 Kg 0.2 £	HOOK







Premium Guide Posts



95 cm metal separator post. high, for area separations and pedestrian guidance. Available in various colors of both pole and 3 m stretch tape length. The head of the post incorporates 3 way attachment. The ribbons can be personalized by screen printing. Ideal for large places or delimiting areas or setting up rows. Also available wall mount version.

Poste separador metálico de 95 cm. de alto, para separaciones de áreas y guiado peatonal. Disponibles en varios colores tanto de poste como de cinta extensible de 3 m. de longitud. El cabezal del poste incorpora 3 vías de enganche. Las cintas pueden personalizarse mediante serigrafía. Ideal para grandes espacios o delimitación de áreas o habilitación de filas. Disponible también elemento mural.

Poteau de séparation métallique de 95 cm. haut, pour les séparations de zone et le guidage piéton. Disponible en différentes couleurs de mât et de ruban, ruban extensible de 3 m. de longueur. La tête du poteau intègre 3 voies de fixation. Les rubans peuvent être personnalisés par sérigraphie. Idéal pour les grands espaces ou délimiter des zones ou mettre en place des rangées. Élément mural également disponible.



Premium Guide posts

808



Sizes

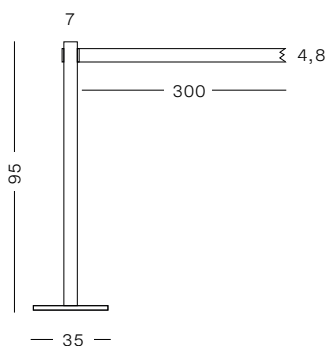

Belt Colours



Data

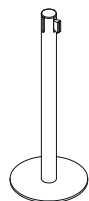

REF	COLOURS	↕ ↔	∅	📦
808	● /NG	95x35 cm 37.4x13.7 in	7 cm 2,7 in	5,8 Kg 12.7 £
808/F	● /GR ● /BL ● /RJ ● /AM ● /AZ ● /VD	95x35 cm 37.4x13.7 in		

REF	↕ ↔	📦
800/TP	7x1 cm 2.7x0.3 in	0,04 Kg 0,08 £
808/F	END POST WITHOUT BELT POSTE FINAL SIN CINTA FIN DE POSTE SANS RUBAN	



800 (wall)



Sizes

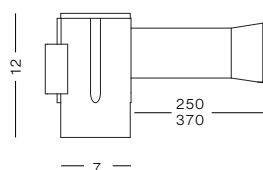

①

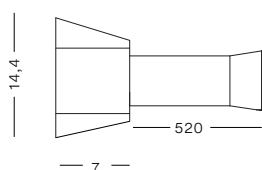

②

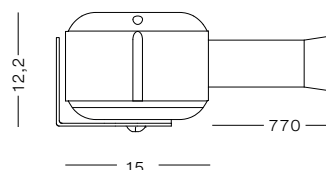

③

Data

REF	↕ ↔	BELT		
800/23	12x7 cm 4.7x2.7 in	4,8x250 cm 1.8x98.4 in	0,4 Kg 0.8 £	①
800/37	12x7 cm 4.7x2.7 in	4,8x370 cm 1.8x145.6 in	0,5 Kg 1.1 £	①
800/52	14,4x7 cm 5.6x2.7 in	4,8x520 cm 1.8x204.7 in	0,7 Kg 1.5 £	②
800/77	12,2x15 cm 4.8x5.9 in	4,8x770 cm 1.8x303 in	0,8 Kg 1.7 £	③

Specs



Personalized

Customize your queu guides with a company or brand logo.
For more information, contact our technical departments.

Consigue una cinta retráctil personalizada con el logotipo de tu empresa o marca. Contacta con nuestra oficina técnica para más detalles.

Obtenir votre sangle retractable personnalisée avec le logo ou la marque de votre entreprise. Contactez nous pour plus de détail.



Accessories



Range of accessories to be placed on the head of the posts, extendable tape separators. Compritable with the Next Eco version and the Premium Guide posts. A4 double-sided poster holder finished in black, gel holder and glove holder in epoxy painted grey.





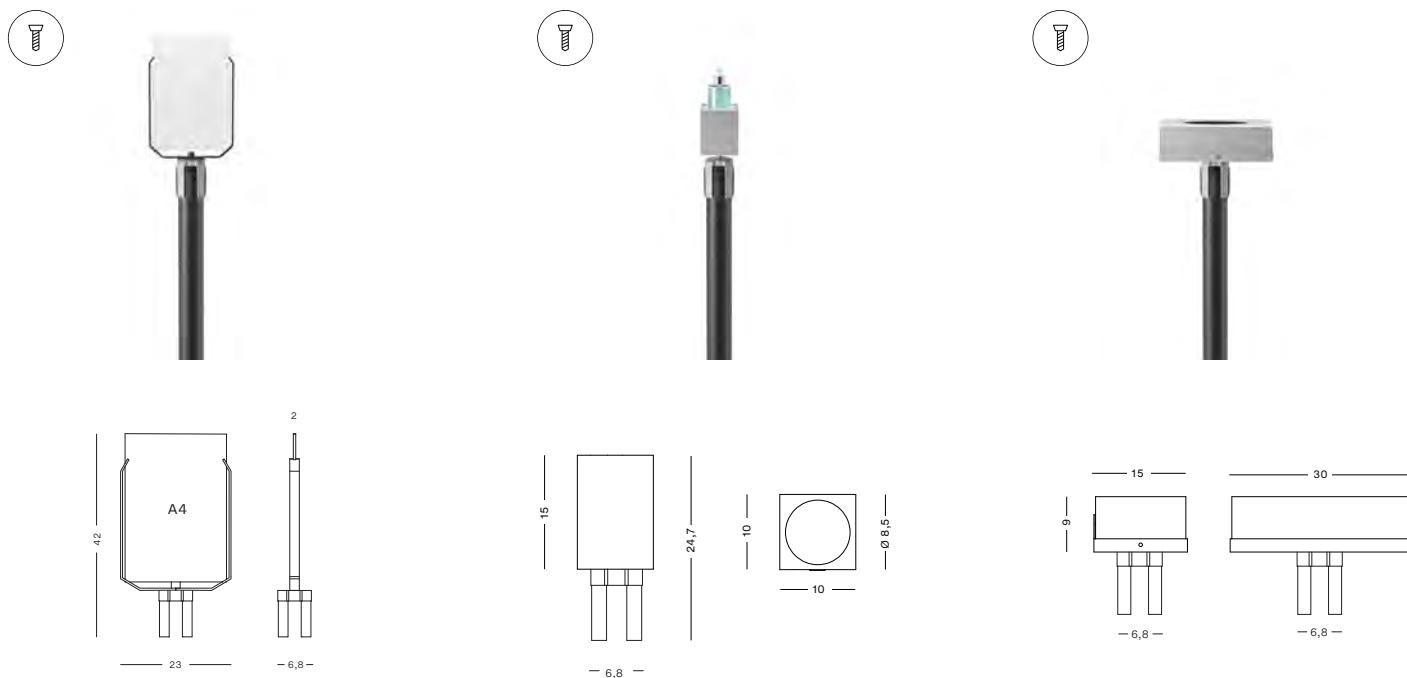

Gama de accesorios para situar en el cabezal de los postes separadores de cinta extensible. Compatibles con la versión Next Eco y la Premium Guide posts. Porta carteles A4 doble cara acabado en negro, porta gel y portaguantes en color gris pintado epoxi.

Gamme d'accessoires à fixer sur le poteau séparateur à sangle rétractable. Compatible avec la version Next Eco et la gamme Premium Guide Post. Porte-affiches A4 double face noire, porte gel et boîte à gants de couleur gris epoxy.

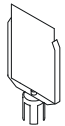
Sizes

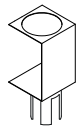

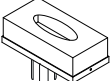
Data

	REF 800/PP	 42x23 cm 16.5x9 in	 2,5 Kg 5.5 £
	REF 800/PSG	 24,7x10 cm 9.7x3.9 in	 1,6 Kg 3.5 £
	REF 800/PCG	 18,7x30 cm 7.3x11.8 in	 3 Kg 6.6 £

Next Eco



Barrier-post eco 95 cm for areas delimitation and users guidance. Black posts, tape available in red or black. One starting slot and 3 ending slots for multiple layouts.

Caja de 2 postes separadores metálicos de 95 cm de alto, para separaciones de áreas y guiado peatonal. Poste de color negro y cinta retráctil de 2 m. Disponible en rojo y negro.

Boîte de 2 postes séparateurs métalliques de 95 cm. de haut pour délimitation d'espaces et guidance des usagers. Poteaux noirs, sangle rouge ou noire. Un départ de sangle et 3 arrivées permettant différentes configurations.

Sizes

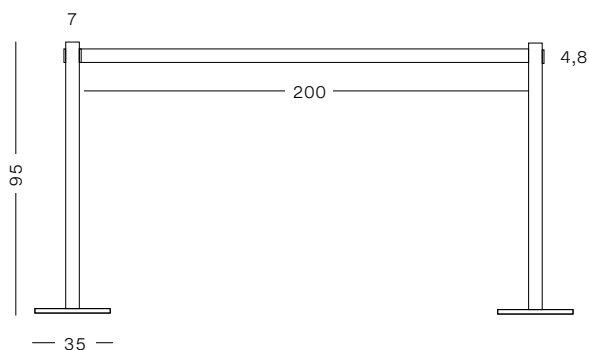

Specs



Colours



Data

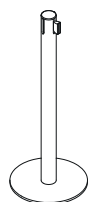

REF	↕ ↔	📏	⌀
803/E2/NG	95x35 cm 37.4x13.7 in	5,8 Kg 12.7 £	7 cm 2,7 in
803/E2/RJ	95x35 cm 37.4x13.7 in	5,8 Kg 12.7 £	7 cm 2,7 in



Basic Guide posts



Aluminum separator post with a black metal base, resistant and highly stable, for separating areas and pedestrian guidance. Post available in 3 colors: black, silver and gold and braided cord 2.5 thick and 1.5 m long, available in 5 colours.

Poste separador de aluminio con base metálica negra, resistente y de gran estabilidad, para separaciones de áreas y guiado peatonal. Poste disponible en 3 colores: negro, plata y dorado con cordón trenzado de 2,5 de grosor y 1,5 m, de longitud, disponible en 5 colores.

Poteau de séparation en aluminium avec une base en métal noir, résistant et très stable, pour la séparation des zones et le guidage des piétons. Poteau disponible en 3 couleurs: noir, argent et or et cordon tressé de 2,5 m d'épaisseur et 1,5 m de long, disponible en 5 couleurs.

Sizes

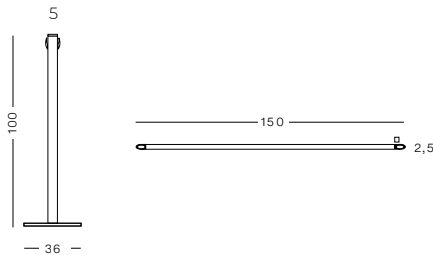
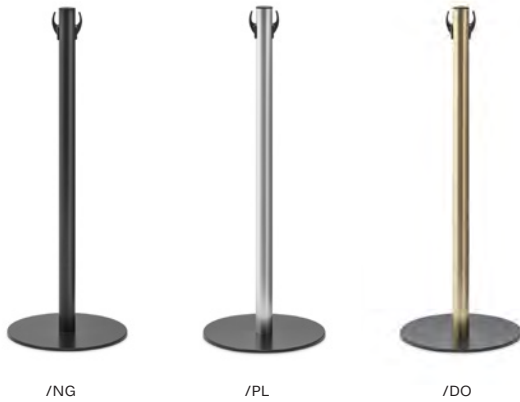

Colours



Options

REF	COLOURS	↕	∅	⚖
805	● /NG	100x36 cm	5 cm	5,8 Kg
	● /PL	39.4x14.2 in	1.9 in	12.7 £
	● /DO			
REF	COLOURS	↔	∅	⚖
805/C	● /NG	150 cm	2,5 cm	0,5 Kg
	● /AZ	59 in	1 in	1.1 £
	● /RJ			
	● /BD			
	● /CR			

* Terminal cord available in Silver & Gold (/PL /DO)
Terminal cordón disponible en Plata & Oro (/PL /DO)
Terminal de corde disponible en Argent et Or (/PL /DO)



Annex

Icons

Inscribable Rotulable <i>Inscriptible</i>	Not Inscribable No rotulable <i>Non-inscriptible</i>	Chalk writing Escritura con tiza <i>Escriture à la craie</i>	Digital use Trazo digital <i>Trait digital</i>	Paper blocs Blocs de papel <i>Blocs papier</i>
Customizable Personalizable <i>Personalisé</i>	Magnetic Magnético <i>Magnétique</i>	Not magnetic No magnético <i>Non-magnétique</i>	Suitable for pins Pinchable <i>Aptes aux punaises</i>	Adhesive Adhesivo <i>Adhésif</i>
Double sided Doble cara <i>Double face</i>	Fitting included Herrajes incluidos <i>Ferrures inclus</i>	Vert. swing door Puerta abatible vertical <i>Porte battante verticale</i>	Hor. swing door Puerta abatible horizontal <i>Porte battante horizontale</i>	Castors included Incluye ruedas <i>Avec roulettes</i>
Leveller Nivelador <i>Niveleur</i>	Adjustable height Ajustable en altura <i>Réglable en hauteur</i>	Flip - flop Volteable <i>Volteable</i>	Sliding doors Puerta corredera <i>Portes coulissantes</i>	Lock included Incluye cerradura <i>Serrure incluse</i>
Security system Sistema seguridad <i>Serrure de sécurité</i>	Water resistant Resistente al agua <i>Resistant à l'eau</i>	Not flammable No inflamable <i>Non-inflammable</i>	Light kit Kit de iluminación <i>Kit lumière</i>	Antibacterial Antibacteriano <i>Antibactérien</i>
Tools included Incluye herramientas <i>Visserie incluse</i>	Ajustable base Ajustable en altura de base <i>Socles ajustables</i>	Acoustic Acústico <i>Acoustique</i>		

Colours

Writeboards and supports

for Frames and Supports



for Glass Board



Pinboards

for Textiles Pinboards



for Chameleon Pinboards



Protect

for Antibacterial Screens



Contract

for Bins



Colours

Acoustic

for PFA Panel



for Foam RAL

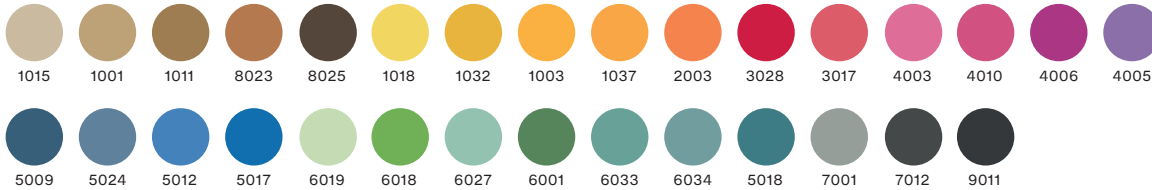

for R·PET Panel



Display

for Belts



for Cords





**Planning
Sisplamo**

Headquarters

Polígono Industrial Pla d'en Coll
Camí de la Font Freda 17, Nave 4
08110 Montcada i Reixac
Barcelona, Spain

T. +34 935 616 595
comercial@planningsisplamo.com
www.planningsisplamo.com

follow us
[@planningsisplamo_ps](https://www.instagram.com/planningsisplamo_ps)

Credits

Concept and Art Direction
The Office of Samuel Lopez

Photography
Befree Studio

Attrezzo
Kave Home
Akaba
JG Group
Emmegi by Frezza

**We love
our planet.**

Printed with
100% recycled
papers



